

ETHERNET

Network Transmission Solutions





Product training availability and scheduling is available on comnet.net. Scan the QR code above with your mobile device to go directly to the Training Page.

In This Brochure:

Hardened Managed Switches	9
Sub-Station Rated Managed Switches	15
Commercial Managed Switches	19
Unmanaged Switches	23
Self-Managed Switches	26
Media Converters	30
Media Converters with PoE	33
Ethernet Integration Products	36
SFP Modules	37

Critical applications demand reliable products. ComNet Ethernet products deliver the highest level of reliability and performance.

ComNet sets the new standard by offering tough transmission equipment backed by an unsurpassed level of support that comes standard with every product we sell. Our innovative equipment is easy to install and operate. With the ComNet Technical Support Team available when you need them, any challenge you may be facing is easily overcome.

ComNet understands Ethernet and wants to share that knowledge with you.

ComNet offers scheduled Ethernet product training classes, webinars and online subject matter to make your understanding of Ethernet greater than ever.



ETHERNET NETWORK TRANSMISSION PRODUCTS

As industry continues the migration toward Ethernet-based network systems, it is more important than ever to be able to turn to a company specifically dedicated to these needs.

ComNet, a USA-based company with the key functions of product development, engineering, manufacturing, customer-care and tech-support headquartered in Danbury, Connecticut, and with sales offices located throughout the world, offers one of the broadest Ethernet product lines in the industry.

ComNet supports its Ethernet products to the highest level, offering unparalleled customer care, technical support and pre- and post-sale support. That's the ComNet difference, behind you every step of the way with a complete line of Ethernet products for every application.

Industrially Hardened All-Gigabit Managed Ethernet Switch Selection Guide

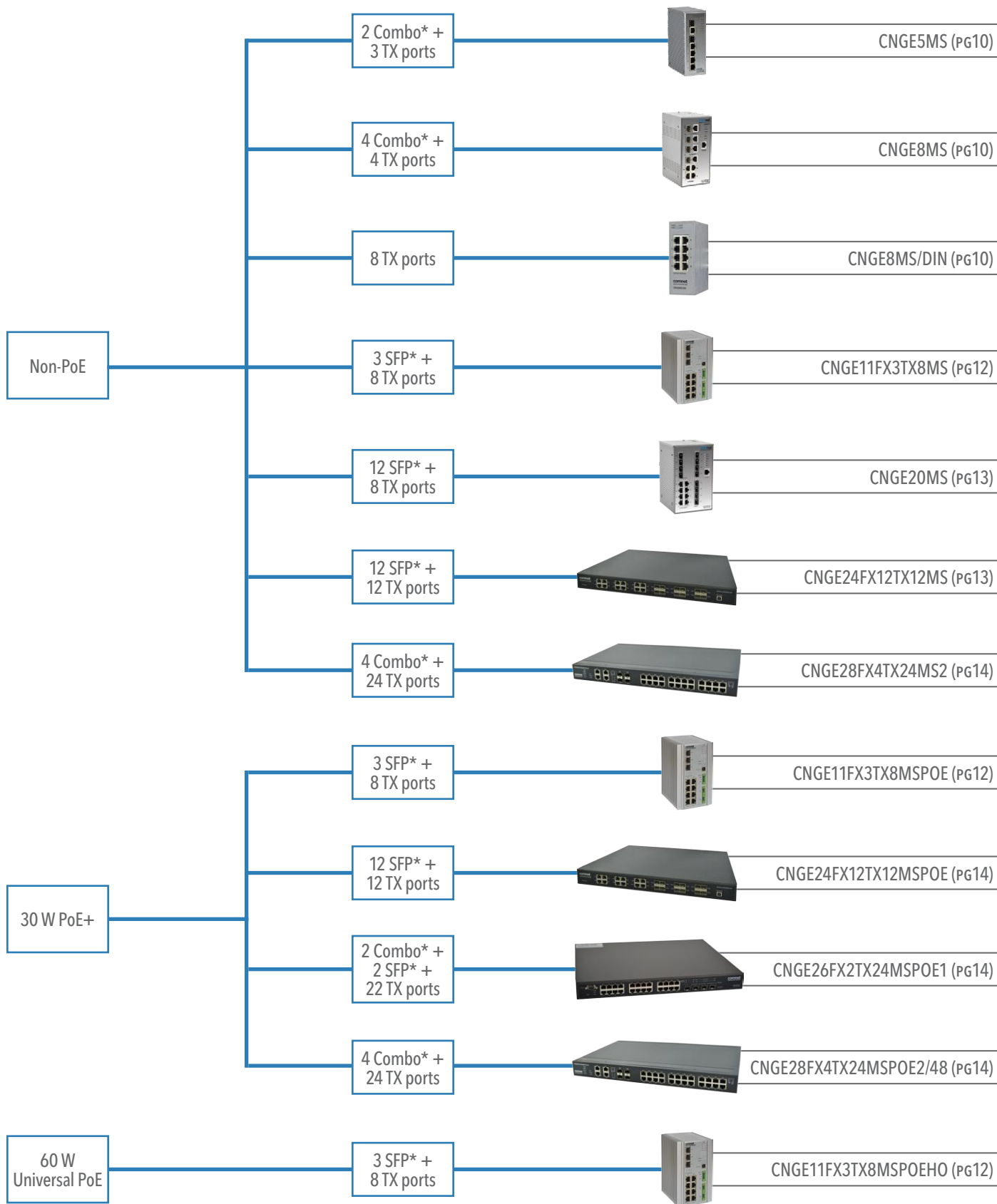

Industrially Hardened 10/100 Mbps Managed Ethernet Switch Selection Guide

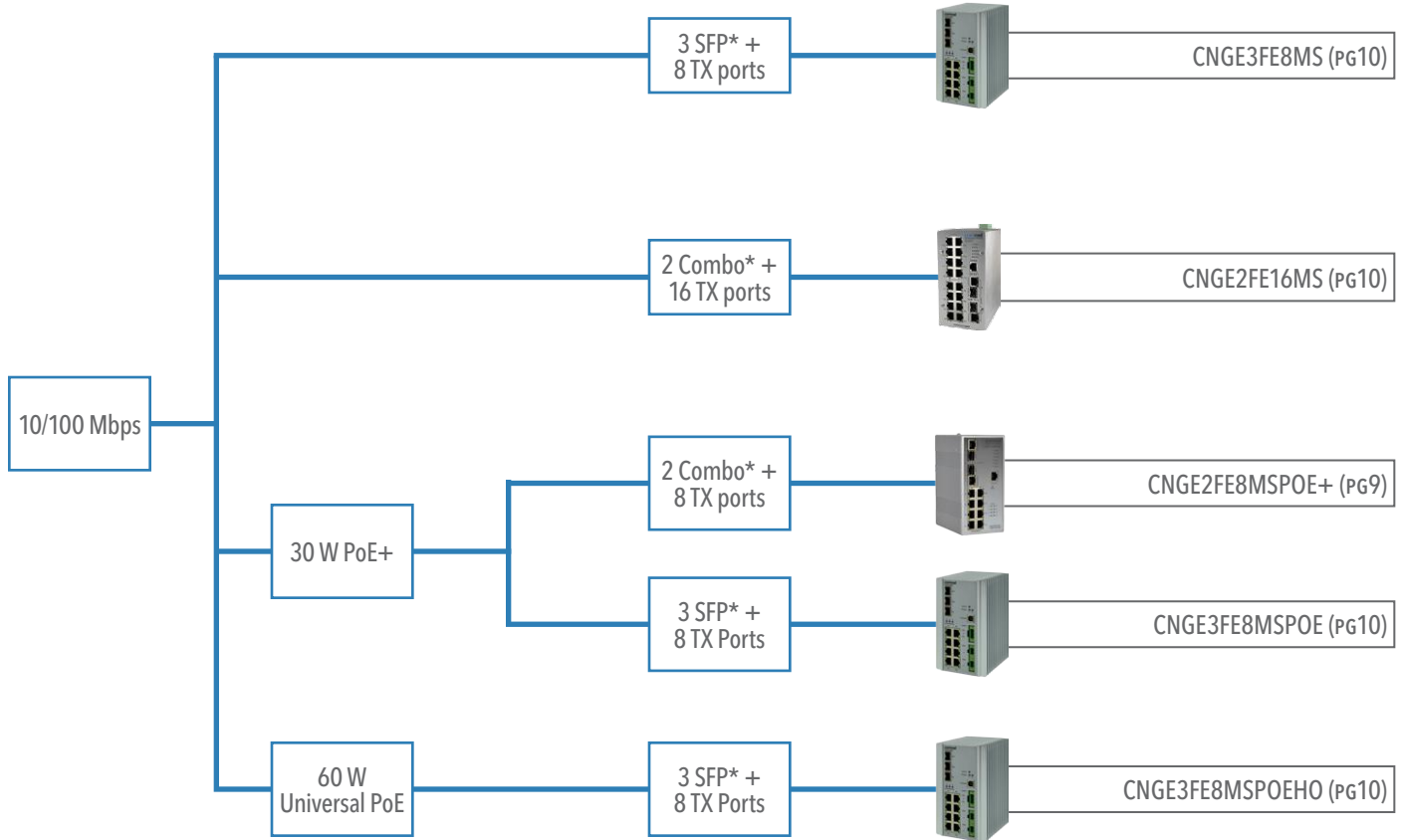

* Requires purchase of SFP modules (sold separately). See Page 37.

Substation Rated Ethernet Transmission Product Selection Guide

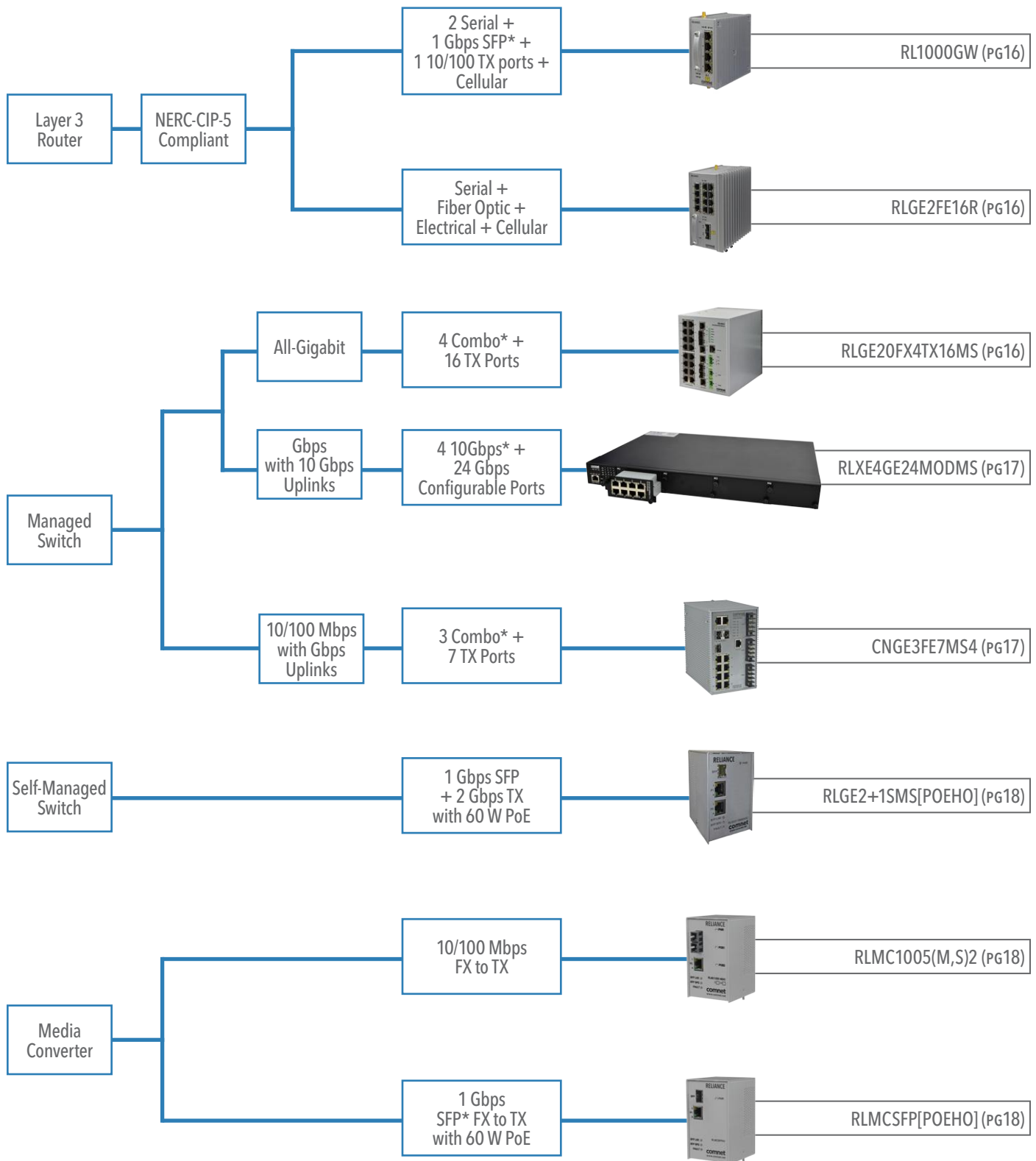

Commercial Managed Ethernet Switch Selection Guide

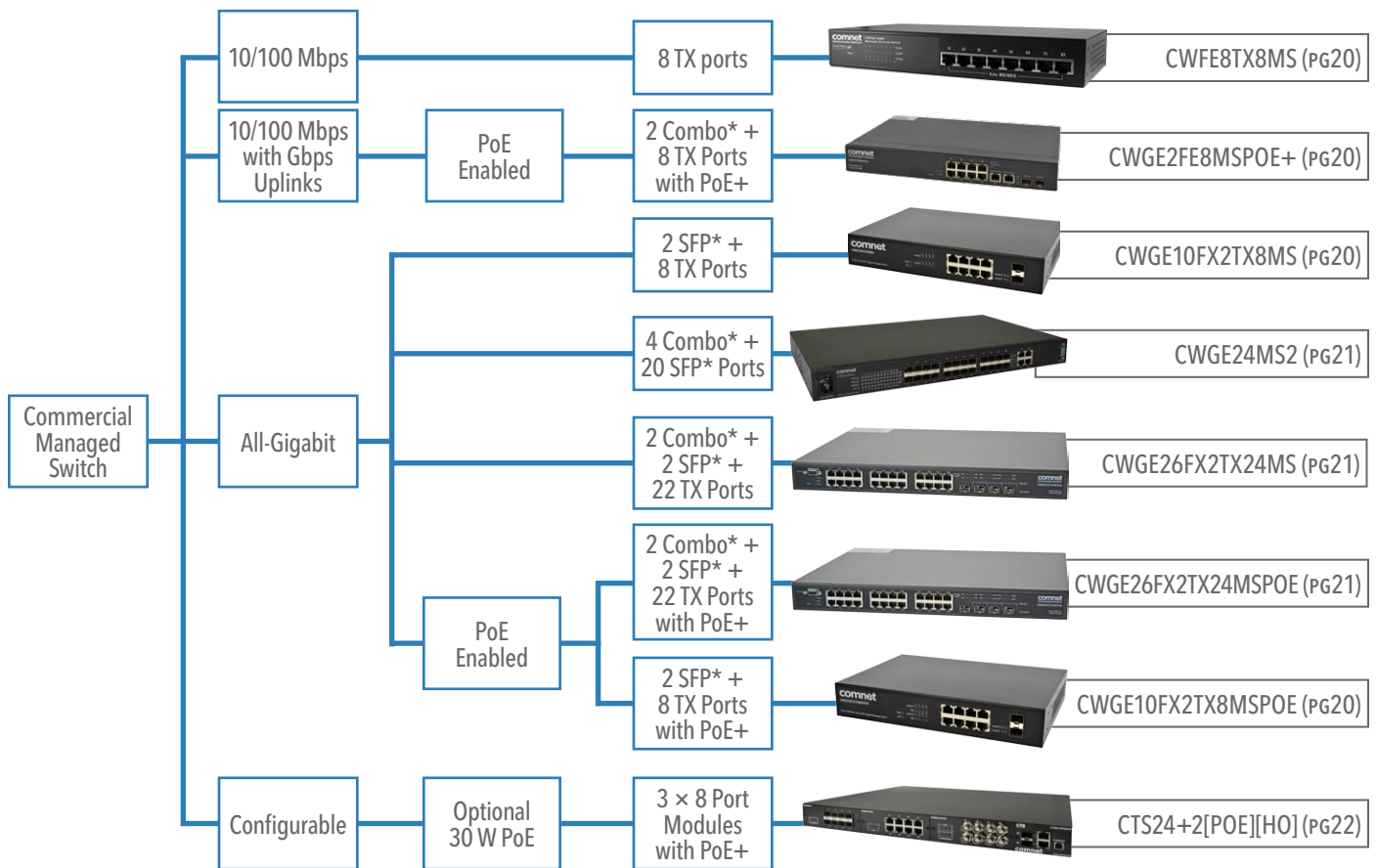

Industrially Hardened Unmanaged Ethernet Switch Selection Guide

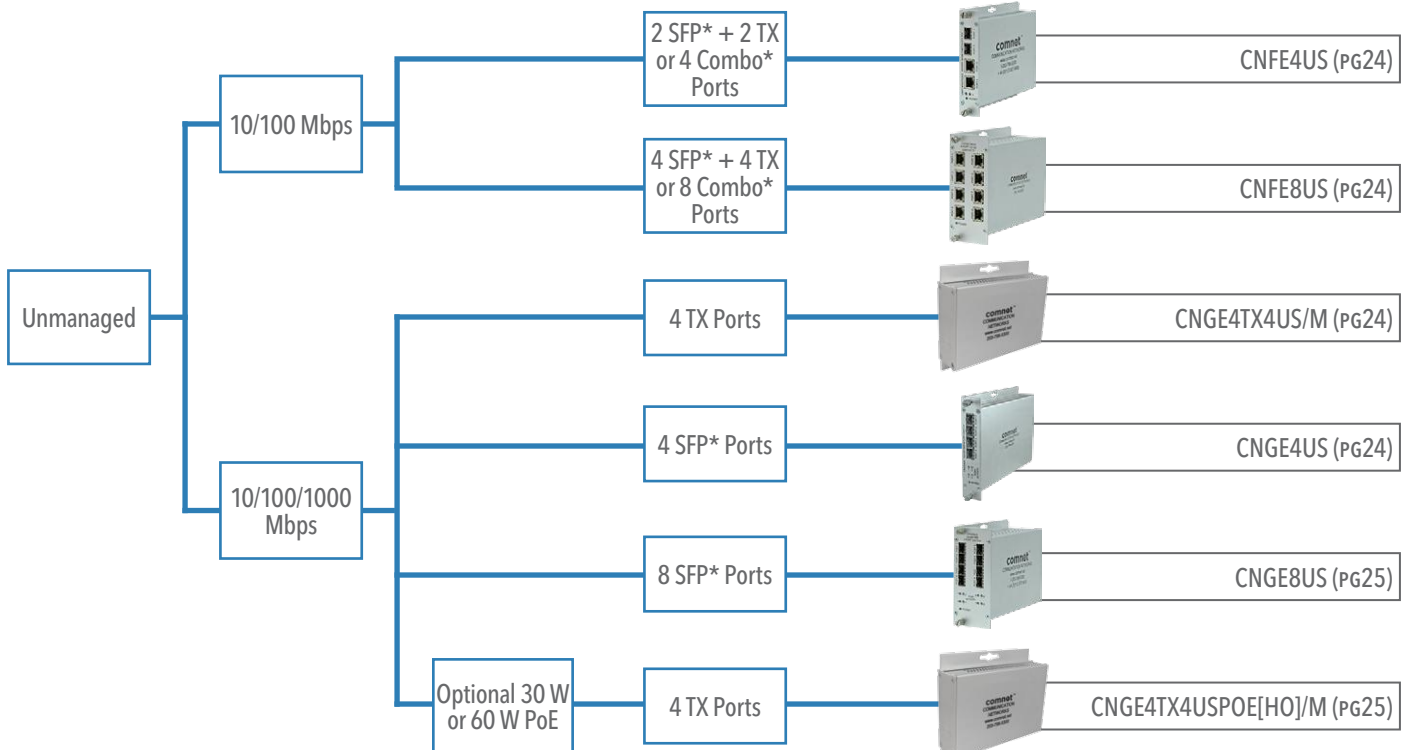

Industrially Hardened Self-Managed Switch Selection Guide

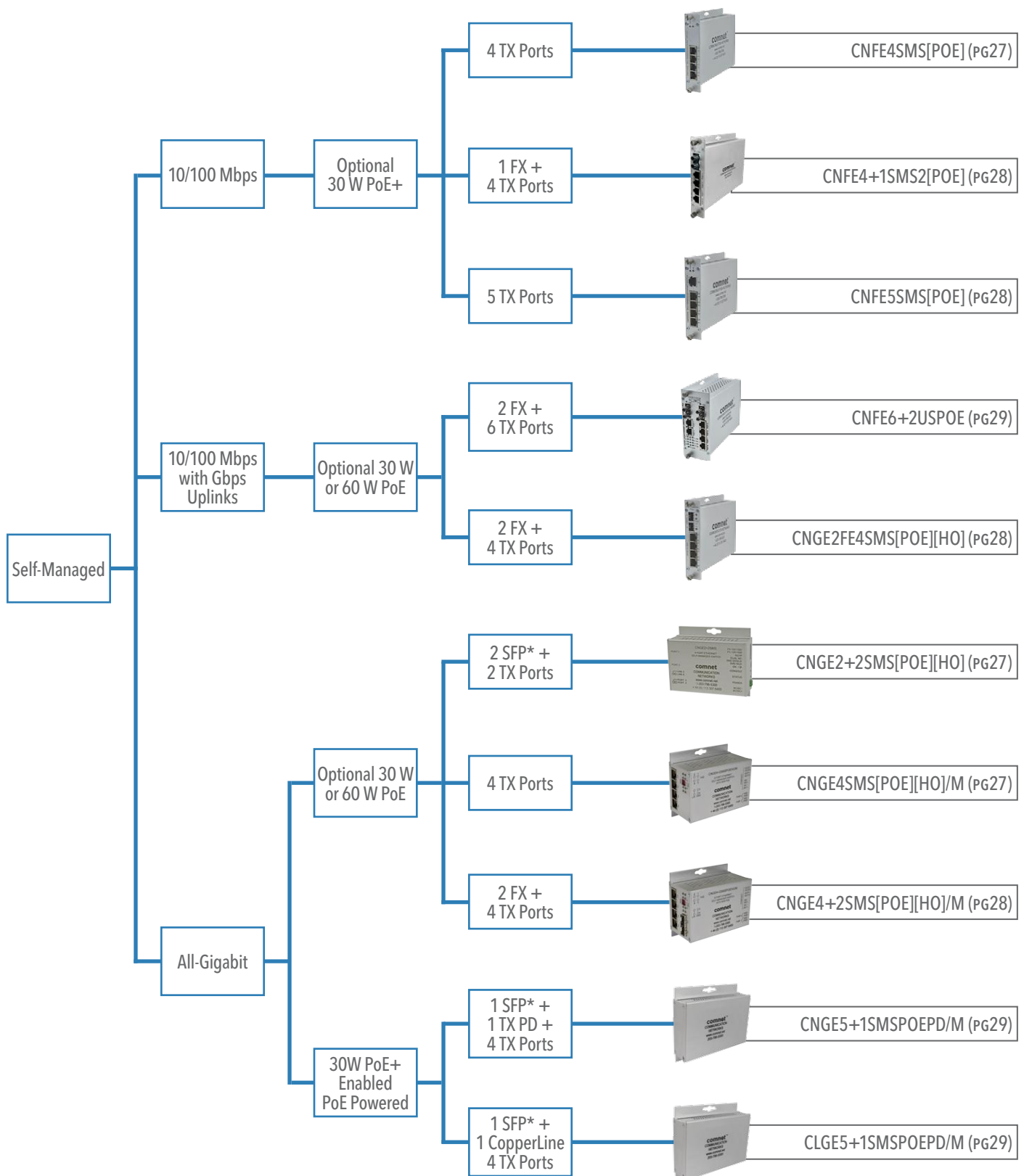

Industrially Hardened Ethernet Media Converter and Extender Selection Guide

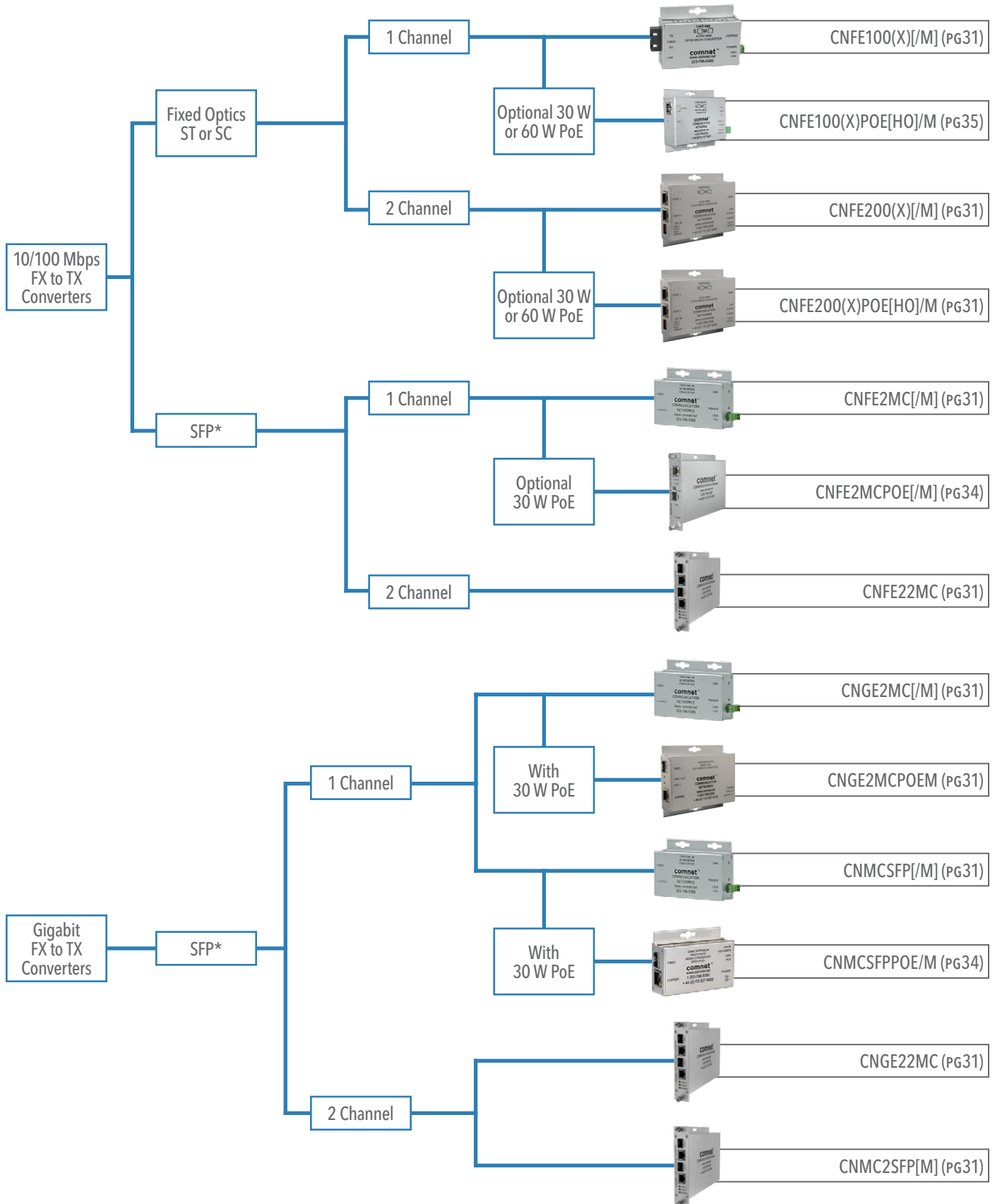

* Requires purchase of SFP modules (sold separately). See Page 37.



netwave®

Wireless Ethernet
transmission made easy.

Power, Point and Play. Power up the units, point the antennas and start transmitting.

The ComNet NetWave® line consists of easy, pre-packaged, Point-to-Point kits that contain everything you need - two units, power supplies, and hardware - to connect one camera or client to an access point. Use the comparison chart below to choose the correct kit for your application.

The NetWave® NWK series offers a complete package solution containing everything you need to transmit a single Ethernet data stream between a Client remote location and the Access Point or head end. A simple antenna alignment feature provides easy to read visual indicators that show when the antennas are correctly aligned and the link is established.

Kit Includes

- › Client (Remote) and Access Point (Head End) in ruggedized IP67 rated heavy duty enclosures
- › Internal Dual Polarized Directional Antenna
- › Distances up to 2 mi (FCC) or 2km (ETSI)
- › Two mounting hardware assemblies
- › Units can optionally be powered by an IEEE 802.3at/ IEEE 802.3af PoE switch
- › Lifetime Warranty

NetWave® Wireless Ethernet Point-to-Point Kits

Product Group	NWK1	NWK1/M	NWK7	NWK7/M	NWK9
Operating Temp Range	-40° to +75°C	-40° to +75°C	-40° to +70°C	-40° to +70°C	-40° to +70°C
Power	Included 48 VDC Passive Power Injector (Included) or PoE	Included 48 VDC Passive Power Injector (Included) or PoE	48 VDC Midspan Injector (optional, order CNGE1IPS) or PoE	48 VDC Midspan Injector (optional, order CNGE1IPS) or PoE	48 VDC Midspan Injector (optional, order CNGE1IPS) or PoE
Internal Dual Polarized Directional Antenna / Beamwidth	19dBi / 17°	16dBi / 30°	19dBi / 17°	16dBi / 30°	19dBi / 17°
Throughput	95 Mbps	95 Mbps	240 Mbps Total Throughput	240 Mbps Total Throughput	500 Mbps Total Throughput
LIFETIME WARRANTY ∞	Yes	Yes	Yes	Yes	Yes

This chart references FCC NetWave models. For ETSI models, please refer to the appropriate data sheets or contact ComNet's International Design Center.



For more information see the ComNet NetWave® Brochure, available in print or online at <http://www.comnet.net/resources/product-literature/>



Environmentally Hardened Managed Ethernet Switches for Use in the Most Demanding Environments

Switches engineered to meet virtually any high bandwidth demand.

In addition, the extra features such as IEEE-compliant PoE and integrated SFP* ports ensure interoperability to other devices and easy to comprehend browser-based interface ensures easy set up and monitoring of your network.

Each ComNet Managed Ethernet Switch features:

- › Optional redundant power supply reduces the possibility of single-point-of-failure
- › Fastest Redundant Ethernet Ring: ComNet C-Ring. Recovery time <30ms
- › Independently tested and certified for full compliance with the environmental requirements of NEMA TS-1/TS-2 and the CALTRANS Specification for Traffic Signal Control Equipment
- › Fully managed, layer 2 switches are optically and electrically compatible with any IEEE 802.3 compliant Ethernet devices
- › Auto-negotiating and auto-MDI/MDIX features are provided for simplicity and ease of installation
- › Flexible optical and copper-based configuration via SFP plug-in modules
- › IGMP Snooping V1/V2 for multicast filtering and IGMP Query V1/V2
- › Rapid Spanning Tree protocol (IEEE 802.1W)
- › Port-based VLAN (IEEE 802.1Q)
- › Environmentally hardened for deployment in difficult, unconditioned out-of-plant and roadside installations, they have an extended ambient operating temperature range of -40° to +75° C
- › Fully configurable through web-based or SNMP network management
- › Port Based Security
- › HD Video Compatible
- › LED indicators for monitoring the operating status of the managed switch and network.
- › Lifetime Warranty

* Requires purchase of SFP modules (sold separately). See Page 37.



CNGE5MS

5-Port All-Gigabit Managed Switch

- 2 Gigabit Combo Ports (SFP/RJ-45)
- 3 Gigabit Copper Ports (TX)

The all-gigabit ComNet CNGE5MS managed redundant-ring Ethernet switch provides three 10/100/1000 BASE-T(X) and two gigabit SFP* or RJ-45 combo ports. The two combo ports are 10/100/1000 Mbps configurable for either CAT-5e copper, or multimode or single-mode optical fiber by the use of optional ComNet SFPs. The exclusive ComNet C-Ring redundancy feature protects applications from network interruptions or temporary malfunctions with its fast recovery technology.

Additional Features

- › IGMP v2/v3 (IGMP snooping support) for filtering multicast traffic
- › Port Trunking for ease of bandwidth management
- › STP/RSTP/MSTP supported
- › Fastest Redundant Ethernet Ring: ComNet C-Ring. Recovery time < 20ms
- › ComRing open architecture-based support for non-ComNet switches within the network



CNGE8MS

8-Port All-Gigabit Managed Switch

- 4 Gigabit Combo Ports (SFP/RJ-45)
- 4 Gigabit Copper Ports (TX)

The all-gigabit ComNet CNGE8MS managed redundant-ring Ethernet switch provides four 10/100/1000BASE-T(X) and four gigabit SFP* or RJ-45 combo ports. The four combo ports are either 10/100/1000 Mbps configurable for CAT-5e copper, or 100/1000FX multimode or single-mode optical fiber by the use of optional ComNet SFPs. The exclusive ComNet C-Ring redundancy feature protects applications from network interruptions or temporary malfunctions with its fast recovery technology.

Additional Features

- › 16 Gbps Switching bandwidth: 4 Combo Gigabit Ports & 4 10/100/1000BASE-T(X) Ports
- › Port Trunking for ease of bandwidth management
- › STP/RSTP/MSTP supported
- › ComRing open architecture-based support for non-ComNet switches within the network
- › Compatible with eConsole Windows utility for centralized management



CNGE8MS/DIN

- 8-Port Managed Switches
- 8 Gigabit Copper Ports (TX)

The CNGE8MS/DIN managed Ethernet switch uses conventional copper transmission media for connectivity. Eight electrical ports are available for easily implementing point-to-point, linear add-drop/drop-and repeat, star or true self-healing ring, and mesh network system architectures. The CNGE8MS/DIN is DIN rail mounted.

Additional Features

- › IEC 62439-2 MRP, STP/RSTP/MSTP, LLDP, SNMP v1/v2c/v3, IPV6, SSH/SSL supported
- › Fastest Redundant Ethernet Ring: ComNet X-Ring+ Recovery time < 30ms
- › Port lock to prevent access from unauthorized MAC address
- › Provides SSH/SSL protocol for enhanced network security





CNGE2FE8MSPOE+

10-Port Managed Switch with 30 W PoE+
 2 Gigabit Combo Ports (SFP/RJ-45)
 8 10/100 Mbps Copper Ports (TX) with PoE

The ComNet CNGE2FE8MSPOE+ provides IEEE 802.3at (30 W) PoE+ to eight 10/100BASE-T(X) and has two-gigabit combination SFP* or RJ-45 ports. The CNGE2FE8MSPOE+ is a redundant switch offering multiple Ethernet redundancy protocols, C-Ring (recovery time <10ms over 250 units of connection), ComRing, and MSTP/RSTP/STP (IEEE 802.1 s/w/D). This redundancy feature protects your applications from network interruptions or temporary malfunctions by redirecting transmission within the network.

Additional Features

- › Eight electrical ports support IEEE.802.3at (30 W) PoE+ with a total PoE budget of 240 W
- › 10/100BASE-TX and 100/100BASE-FX compatible
- › Redundant power supply reduces possibility of single-point-of-failure
- › Compatible with eConsole Windows utility for centralized management
- › Fully configurable through CLI, web-based or SNMP network management

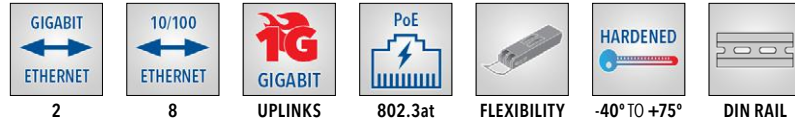

CNGE3FE8MS

11-Port Managed Switch
 3 Gigabit SFP Ports (FX)
 8 10/100 Mbps Copper Ports (TX)

MADE IN THE USA

The ComNet CNGE3FE8MS has three 100/1000Base-FX SFP* ports and eight 10/100Base-TX ports. Two of the SFP ports support 2.5 Gbps SFPs for high speed communication in bandwidth intensive applications. The IEEE802.3-compliant unit offers multiple Ethernet redundancy protocols to protect your applications from network interruptions. The switch provides advanced IP-based management that can limit the maximum bandwidth for each connected IP device, allowing the user to adjust usage.

Additional Features

- › Two SFP ports support 2.5 Gbps SFP modules for high speed communication
- › Fast Redundancy/Recovery – MSTP/RSTP/STP (IEEE802.1s/w/D) and ERPS G.8032



CNGE3FE8MSPOE[HO]

11-Port Managed Switch with 30 W PoE+ / 60 W Universal PoE
 3 Gigabit SFP Ports (FX)
 8 10/100 Mbps Copper Ports (TX) with PoE

MADE IN THE USA

The ComNet CNGE3FE8MS[POE][HO] has three 100/1000Base-FX SFP* ports and eight 10/100Base-TX ports. Two of the SFP ports support 2.5 Gbps SFPs for high speed communication in bandwidth intensive applications. The IEEE802.3-compliant unit offers multiple Ethernet redundancy protocols to protect your applications from network interruptions. Two PoE models are available; the CNGE3FE8MSPOE features 8 Ports that provide up to 30 Watts of PoE. The CNGE3FE8MSPOEHO features four ports that can provide up to 60 watts and four that provide 30 watts of PoE power.

Additional Features

- › Two SFP ports support 2.5 Gbps SFP modules for high speed communication
- › Fast Redundancy/Recovery – MSTP/RSTP/STP (IEEE802.1s/w/D) and ERPS G.8032

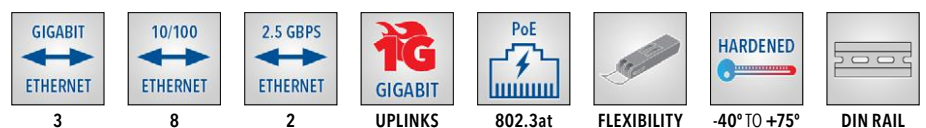

* Requires purchase of SFP modules (sold separately). See Page 37.



CNGE11FX3TX8MS
11-Port All-Gigabit Managed Switch
 3 Gigabit SFP Ports (FX)
 8 Gigabit Copper Ports (TX)

MADE IN THE USA

The ComNet CNGE11FX3TX8MS has three 100/1000Base-FX SFP* ports and eight 10/100/1000Base-TX ports. Two of the SFP ports support 2.5 Gbps SFPs for high speed communication in bandwidth intensive applications. The IEEE802.3-compliant unit offers multiple Ethernet redundancy protocols that protect your network from failure. The switch provides advanced IP-based management that can limit the maximum bandwidth for each connected IP device, allowing the user to adjust usage.

Additional Features

› Fast Redundancy/Recovery – MSTP/RSTP/STP (IEEE802.1s/w/D) and ERPS G.8032

					
3 + 8	2	ALL GIGABIT	FLEXIBILITY	-40° TO +75°	DIN RAIL



CNGE11FX3TX8MSPOE[HO]
11-Port All-Gigabit Managed Switch with 30 W PoE+ / 60 W Universal PoE
 3 Gigabit SFP Ports (FX)
 8 Gigabit Copper Ports (TX) with PoE

MADE IN THE USA







The ComNet CNGE11FX3TX8MS[POE][HO] has three 100/1000Base-FX SFP* ports and eight 10/100/1000Base-TX ports. Two of the SFP ports support 2.5 Gbps SFPs for high speed communication in bandwidth intensive applications. The IEEE802.3-compliant unit offers multiple Ethernet redundancy protocols that protect your network from failure. The switch provides advanced IP-based management that can limit the maximum bandwidth for each connected IP device, allowing the user to adjust usage. Two PoE models are available.

Additional Features

› Fast Redundancy/Recovery – MSTP/RSTP/STP (IEEE802.1s/w/D) and ERPS G.8032

› CNGE11FX3TX8MSPOE provides eight 30 W PoE+ ports

› CNGE11FX3TX8MSPOEHO provides four 30 W PoE+ ports and four 60 W Universal PoE ports

						
3 + 8	2	ALL GIGABIT	802.3at	FLEXIBILITY	-40° TO +75°	DIN RAIL









CNGE2FE16MS
18-Port Managed Switch
 2 Gigabit Combo Ports (SFP/RJ-45)
 16 10/100 Mbps Copper Ports (TX)

The ComNet CNGE2FE16MS managed Ethernet switch provides sixteen 10/100BASE-TX and two 10/100/1000T(X) or 100/1000FX (gigabit) combo ports. These environmentally hardened units are available for use with either conventional CAT-5e copper or optical transmission media by user selectable SFP*s. The CNGE2FE16MS is approved for use in most industrial control applications.

Additional Features

› Compliant with EN60950-1 and UL Class 1, Division 2, Groups A, B, C and D for Hazardous Locations

› STP/RSTP supported

						
2	16	UPLINKS	FLEXIBILITY	-40° TO +75°	INCLUDED	DIN RAIL

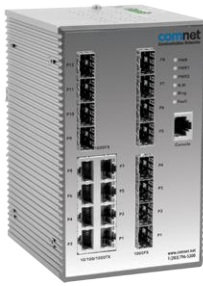





CNGE20MS
20-Port All-Gigabit Managed Switch
 8 Gigabit Copper Ports (TX)
 12 Gigabit SFP Optical Ports (FX)

The ComNet CNGE20MS Managed Ethernet Switch features eight 10/100/1000BASE-TX and twelve 100/1000BASE-FX SFP* ports. The SFP ports are 100/1000 Mbps configurable for either multimode or single-mode optical fiber by the use of optional ComNet SFPs. Redundant DC inputs are included for uninterrupted operation in the event of a power supply failure.

Additional Features

- › Supports Jumbo Frame up to 9K Bytes for streaming video applications
- › STP/RSTP/MSTP supported
- › Compatible with eConsole Windows utility for centralized management

					
8 + 12	ALL GIGABIT	FLEXIBILITY	-40° TO +75°	INCLUDED	DIN RAIL



CNGE24FX12TX12MS
24-Port All-Gigabit Managed Switch
 12 Gigabit SFP Ports (FX)
 12 Gigabit Copper Ports (TX)

MADE IN THE USA

The ComNet CNGE24FX12TX12MS has twelve 100/1000Base-FX SFP* ports and twelve 10/100/1000Base-TX ports. The IEEE802.3-compliant unit offers multiple Ethernet redundancy protocols that help protect your network from a failure. The switch provides advanced IP-based management that can limit the maximum bandwidth for each connected IP device, allowing the user to adjust usage. The Device-Binding function can prevent unauthorized network access, increasing security. The CNGE24FX12TX12MS also provides advanced DOS/DDOS auto prevention, if data flow becomes too large, too quickly, the switch will lock the source IP address for a set period preventing unauthorized access.

Additional Features

- › 2 SFP ports support 2.5 Gbps for high speed communication in bandwidth intensive applications
- › Fast Redundancy/Recovery – MSTP/RSTP/STP (IEEE802.1s/w/D) and ERPS G.8032







				
12 + 12	2	ALL GIGABIT	FLEXIBILITY	-40° TO +60°



CNGE24FX12TX12MSPOE
24-Port All-Gigabit Managed Switch with 30 W PoE+
 12 Gigabit SFP Ports (FX)
 12 Gigabit Copper Ports (TX) with PoE

MADE IN THE USA

The ComNet CNGE24FX12TX12MSPOE has twelve 100/1000Base-FX SFP* ports and twelve 10/100/1000Base-TX ports. The IEEE802.3-compliant unit offers multiple Ethernet redundancy protocols that help protect your network from failure. The switch provides advanced IP-based management that can limit the maximum bandwidth for each connected IP device, allowing the user to adjust usage. The Device-Binding function can prevent unauthorized network access, increasing security. The CNGE24FX12TX12MSPOE also provides advanced DOS/DDOS auto prevention, if data flow becomes too large, too quickly, the switch will lock the source IP address for a set period preventing unauthorized access.

					
12 + 12	2	ALL GIGABIT	802.3at	FLEXIBILITY	-40° TO +60°







* Requires purchase of SFP modules (sold separately). See Page 37.



CNGE26FX2TX24MSPOE1

26-Port Managed Switch with 30 W PoE+
 2 Gigabit SFP Ports (FX)
 2 Gigabit Combo Ports (SFP/RJ45) with PoE
 22 Gigabit Copper Ports (TX) with PoE

The ComNet CNGE26FX2TX24MSPOE1 is an industrially hardened Managed Ethernet Switch. It provides IEEE 802.3at PoE to twenty-four 10/100/1000BASE-T(X) two of which are also gigabit combo ports supporting 100/1000Fx SFP Modules. A further two-100/1000FX SFP* ports are also included. Up to 720 watts of PoE power is available for distribution across all 24 TX ports. The CNGE26FX2TX24MSPOE1 is a redundant switch offering multiple Ethernet redundancy protocols to protect your applications from network interruptions or temporary malfunctions by redirecting transmission within the network.

					
2 + 2 + 22	ALL GIGABIT	802.3at	FLEXIBILITY	-20° TO +60°	INTERNAL



CNGE28FX4TX24MS2

28-Port Managed Switch
 4 Gigabit Combo Ports (SFP/RJ-45)
 24 Gigabit Copper Ports (TX)

The ComNet CNGE28FX4TX24MS2 Layer 2 Managed 28 Port Ethernet Switch supports twenty-four 10/100/1000 BASE-TX ports and four 10/100/1000 BASE-TX or 100/1000 BASE-FX SFP* Combo ports of Ethernet data. The four combination ports are 10/100/1000TX or 100/1000FX SFP configurable for fiber type (multimode or single-mode), connector type and distance. Utilizing RSTP/STP (802.1w/1D) MSTP, and X-Ring redundant ring topologies, a network recovery time of <20 ms is provided for protection from network faults or temporary interruptions. Dual 12-48 VDC input power design ensures vital network capabilities with minimum downtime.





			
24 + 4	ALL GIGABIT	FLEXIBILITY	-40° TO +75°



CNGE28FX4TX24MSPOE2/48

28-Port Managed Switch with 30 W PoE+
 4 Gigabit Combo Ports (SFP/RJ-45)
 24 Gigabit Copper Ports (TX) with PoE

The ComNet CNGE28FX4TX24MSPOE2/48 Layer 2 Managed 28 Port Ethernet Switch supports twenty-four 10/100/1000 BASE-TX ports and four 10/100/1000 BASE-TX or 100/1000 BASE-FX SFP Combo ports of Ethernet data. The four combination ports are 10/100/1000TX or 100/1000FX SFP* configurable for fiber type (multimode or single-mode), connector type and distance. Dual 48 VDC input power design ensures vital network capabilities with minimum downtime. Utilizing RSTP/STP (802.1w/1D) MSTP, and X-Ring redundant ring topologies, a network recovery time of <20 ms is provided for protection from network faults or temporary interruptions.

				
24 + 4	ALL GIGABIT	802.3at	FLEXIBILITY	-40° TO +75°

RELIANCE

Substation Rated

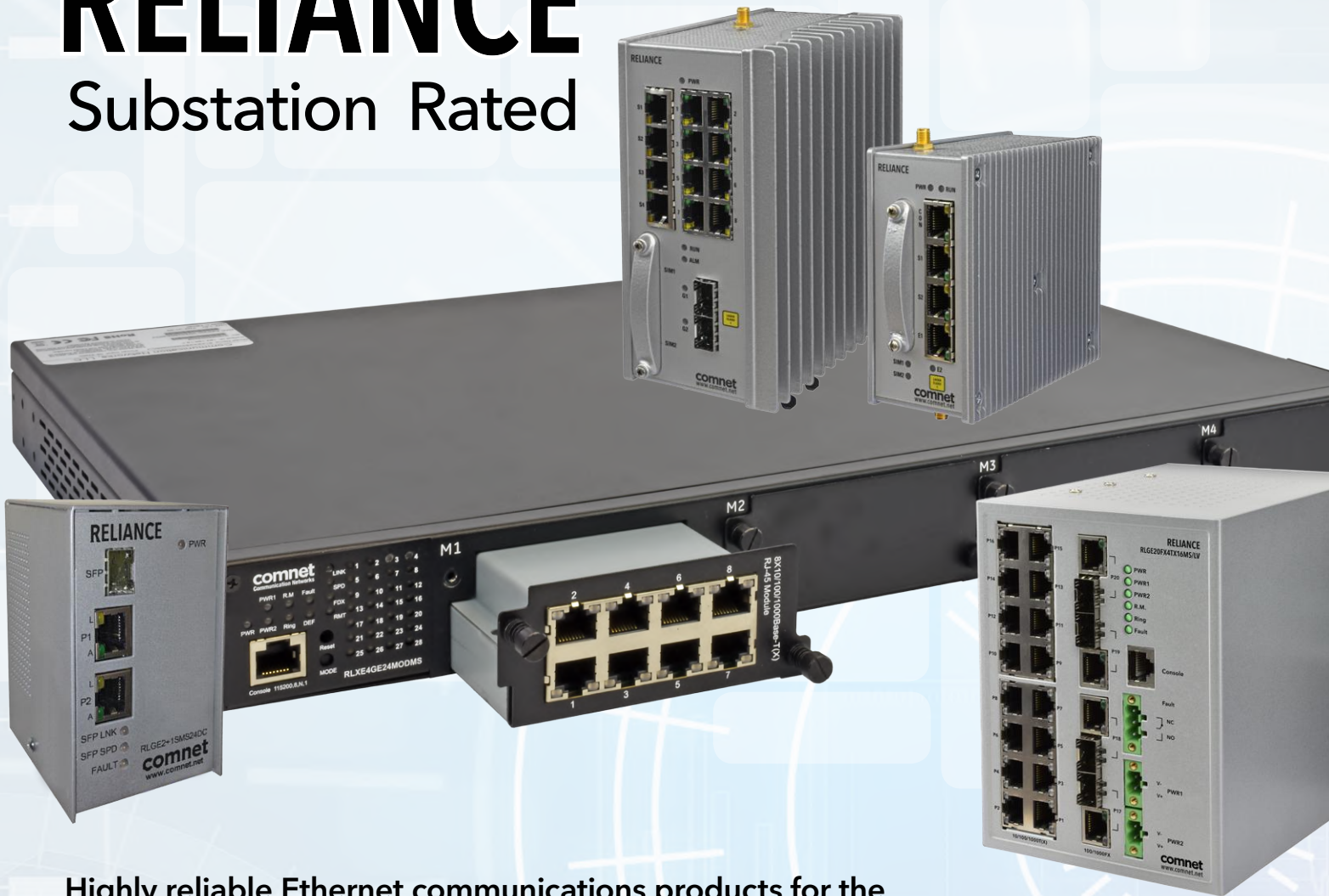

Highly reliable Ethernet communications products for the Electric Power, Transmission & Distribution Industry.

Ruggedized Fiber optic, wireless, and copper media-based Ethernet, serial data, contact closure, T-1/E-1 telephony, audio, and video transmission equipment designed to solve the challenges encountered in harsh or difficult industrial and out-of-plant environments



RL1000GW

Secure Layer 3 Router/Gateway

1 or 2 RS-232 RJ-45 serial port(s), with control lines

1 RS-485 RJ-45 Serial Port

1 Gigabit SFP Port (FX)

1 10/100 Copper Port (TX)

The ComNet RL1000GW is a series of substation-rated and industrially hardened layer 3 router/ gateways, with a unique packet processing SCADA-aware security firewall for demanding cyber-security applications. The RL1000GW is intended for deployment in environments where high levels of electromagnetic noise and interference (EMI) and severe voltage transients and surges are encountered. Layer 3 routing functionality allows for the participation and foundation of a core network infrastructure.

Additional Features

- › IEC 61850-3 and IEEE 1613 Class 2, and NEMA TS-1/TS-2 Compliant
- › For NERC-CIP-5 and NERC-CIP-014 compliance, or any network application demanding effective cyber-security protection
- › Optional internal 2G/3G/4G LTE GPRS/UMTS cellular radio modem with 2 SIM card slots



RLGE2FE16R

18-Port Substation-Rated, Enhanced Security SCADA-Aware Layer 2 Managed Switch/Layer 3 Router

2 Gigabit SFP Ports (FX)

16 10/100 Mbps Copper Ports (TX)

The ComNet RLGE2FE16R is a series of substation-rated and industrially hardened layer 2 managed switches/layer 3 routers, with a unique packet processing SCADA-aware security firewall for the most demanding cyber-security applications. The RLGE2FE16R is intended for deployment in environments where high levels of electromagnetic noise and interference (EMI) and severe voltage transients and surges occur. Layer 3 routing functionality allows for the participation and foundation of a core network infrastructure. The RLGE2FE16R is an ideal platform for deploying a secure communications and networking gateway for all critical infrastructure applications.

Additional Features

- › IEC 61850-3 and IEEE 1613 Class 2, and NEMA TS-1/TS-2 Compliant
- › For NERC-CIP-5 and NERC-CIP-014 compliance, or any network application demanding effective cyber-security protection
- › Optional internal 2G/3G/4G LTE GPRS/UMTS cellular radio modem with 2 SIM card slots
- › PoE+ Model Available: 30 watts per port, 8 ports max.

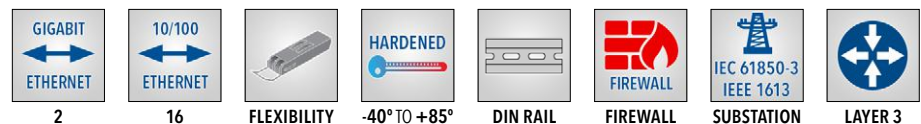

RLGE20FX4TX16MS

20-Port All-Gigabit Managed Layer 2 Switch

4 Gigabit Combo Ports (SFP/RJ-45)

16 Gigabit Copper Ports (TX)

The ComNet RLGE20FX4TX16MS series is a substation-rated and industrially hardened all-gigabit managed layer 2 switch. The RLGE20FX4TX16MS features 16 10/100/1000BASE-TX ports, with 4 selectable 10/100/1000BASE-TX or 100/1000BASE-FX SFP* ports. The RLGE20FX4TX16MS can be used in environments where high levels of electromagnetic noise and interference (EMI) and severe voltage transients and surges occur. The internal/self-contained 12 to 60 VDC or 85 to 264 VAC/88 to 373 VDC power supply features redundant power inputs, for the highest reliability.

Additional Features

- › Fast Redundancy/Recovery - MSTP/RSTP/STP/C-Ring/Com-Ring
- › VLAN Unaware: Supports priority-tagged frames to be received by specific Intelligent Electronic Devices





CNGE3FE7MS4

10-Port Managed Switch
 3 Gigabit Combo Ports (SFP/RJ-45)
 7 10/100 Mbps Copper Ports (TX)

The ComNet CNGE3FE7MS4 is a substation-rated and industrially hardened fully managed layer 2, gigabit Ethernet switch. It is designed for deployment in environments where high levels of electromagnetic noise and interference (EMI) and severe voltage transients and surges are routinely encountered, such as electrical utility substations and switchyards, heavy manufacturing facilities, trackside and roadside electronic equipment, and other difficult out-of-plant applications.

Additional Features

- › Fully compliant with the requirements of IEC 61850-3 and IEEE 1613 Class 2 for electrical utility substations, EN50155 for railway applications, and NEMA TS-1/TS-2 for traffic signal control equipment
- › Compliant with EN60950-1 and UL Class 1, Division 2, Groups A, B, C and D for Hazardous Locations
- › Internal/self-contained 85-264 VAC/88-373 VDC power supply
- › Environmentally hardened for deployment in difficult unconditioned out-of-plant and roadside installations
- › Conformal coated for humidity with condensation or airborne particulate matter conditions



RLXE4GE24MODMS

**All-Gigabit Modular Layer 2 Switch/
 Layer 3 Router, with 10 Gbps SFP Ports**
 4 10 Gbps Uplink SFP Ports (FX)
 24 Gigabit Ports (Option dependent)

The ComNet RLXE4GE24MODMS is a substation-rated and industrially hardened, all-gigabit managed layer 2 switch/layer 3 router. The RLXE4GE24MODMS is a fully modular switch that allows the user to choose between 10Gbps and Gigabit modules to custom configure the switch. Four slots are provided in the chassis for accommodating individual modules featuring different combinations of SFP* and electrical 10/100/1000BASE-TX ports. Individual modules that feature different numbers of TX, FX SFP and fixed SC or ST optical connections with counts of 2, 4 and 8 port modules available. It is designed for use in environments where high levels of electromagnetic noise and interference (EMI) and severe voltage transients and surges are encountered. The layer 3 static routing functionality allows for the participation and foundation of a core network infrastructure.

Additional Features

- › Dual user-replaceable redundant power supply modules provide reliable operation
- › Layer 3 static routing, RIP, and VRRP functions
- › Fast Redundancy/Recovery – MSTP/RSTP/STP/C-Ring/Com-Ring
- › Compliant with the requirements of IEC 61850-3 and IEEE 1613 Class 2, for use in electrical utility substations; NEMA TS-1/ TS-2 for Traffic Signal Control Equipment; and EN50155 for railway applications



* Requires purchase of SFP modules (sold separately). See Page 37.



RLGE2+1SMS[POEHO]

3-Port All-Gigabit Self-Managed Switch with 60 W Universal PoE

- 1 Gigabit SFP Port (FX)
- 2 Gigabit Copper Ports (TX) with PoE

MADE IN THE USA

The ComNet RLGE2+1SMSPOEHO is a substation-rated and industrially hardened 3-port self-managed Ethernet switch with uplink management capability. It is intended for use in environments where high levels of electromagnetic noise and interference (EMI) and severe voltage transients and surges are routinely encountered, such as electrical utility substations and switchyards, heavy manufacturing facilities, trackage and roadside electronic equipment, and other difficult out-of-plant applications. The RLGE2+1SMSPOEHO comes pre-programmed, preventing network video flooding with DIP-switch selection of the SFP port as uplink or as an unmanaged switch. Two models are available, a standard model and a PoE (power over Ethernet) model that supports PoE powered devices requiring up to 60 watts of operating power.



RLMC1005(M,S)2

2-Port Media Converter

- 1 100 Mbps Optical Port (FX)
- 1 10/100 Mbps Copper Port (TX)

MADE IN THE USA

The ComNet RLMC1005 is a substation-rated and hardened Ethernet media converter. Designed to the requirements of IEC 61850-3, IEEE 1613 Class 2, EN50155, and NEMA TS-1/TS-2, it is intended for deployment in environments where high levels of electromagnetic noise and interference (EMI) and severe voltage transients and surges occur, such as electrical utility substations and switchyards, heavy manufacturing facilities, trackage and roadside electronic equipment, and other difficult out-of-plant applications. The 100BASE-FX port supports optical transmission over two multimode or single-mode fibers and comes with ST optical connectors.

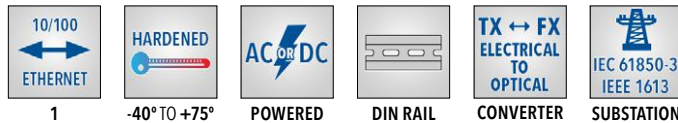

RLMCSFP[POEHO]

2-Port 10/100/1000 Mbps Media Converter with 60 W Universal PoE

- 1 Gigabit SFP Port (FX)
- 1 Gigabit Copper Port (TX) with Optional PoE

MADE IN THE USA

The ComNet RLMCSFPPOEHO is a substation-rated and hardened Ethernet media converter. Designed to the requirements of IEC 61850-3, IEEE 1613 Class 2, EN50155, and NEMA TS-1/TS-2, it is intended for deployment in environments where high levels of electromagnetic noise and interference (EMI) and severe voltage transients and surges occur, such as electrical utility substations and switchyards, heavy manufacturing facilities, trackage and roadside electronic equipment, and other difficult out-of-plant applications. The DIP-switch-selectable 100BASE-FX or 1000BASE-FX port supports optical transmission media with selection of the appropriate ComNet SFP* module. Two models are available, a standard model and a PoE (power over Ethernet) model that supports PoE powered devices requiring up to 60 watts of operating power.



ValueLine: Feature-Rich, Cost-Effective Managed Ethernet Switches For Commercial Applications



ComNet offers the ValueLine Ethernet transmission products designed for use in commercial operating environments.

These ValueLine switches and media converters offer many of the same operational features as environmentally hardened and are some of the most competitively priced Ethernet equipment currently available.

ValueLine Managed Ethernet Switches feature:

- › Fully managed, layer 2 switches are optically and electrically compatible with any IEEE 802.3 compliant Ethernet devices
- › Auto-negotiating and auto-MDI/MDIX features are provided for simplicity and ease of installation
- › Flexible optical and copper-based configuration via SFP* plug-in modules
- › IGMP Snooping V1/V2 for multicast filtering and IGMP Query V1/V2
- › Rapid Spanning Tree protocol (IEEE 802.1W)
- › Port-based VLAN (IEEE 802.1Q)
- › Fully configurable through web-based or SNMP network management
- › Rack mounting brackets available which allow CW Series switches to be mounted in 19-inch electronics racks
- › Port Based Security
- › HD Video Compatible
- › Five-Year Warranty

* Requires purchase of SFP modules (sold separately). See Page 37.



CWFE8TX8MS

8-Port Managed Switch

8 10/100 Mbps Copper Ports (TX)

Operating temperature range of 0° to +50° C

The ComNet CWFE8TX8MS Managed Ethernet Switch provides transmission of 10/100 BASE-TX Ethernet data. Up to 8 electrical ports are available for easily implementing point-to-point, linear add-drop, drop-and-repeat, star or true self-healing ring and mesh network system architectures. Auto-negotiating and auto-MDI/MDIX features are provided for simplicity and ease of installation.

Additional Features

› Stand alone mounting

› Internal Power Supply 100-240 VAC Input

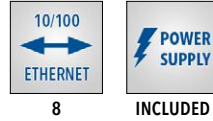

CWGE2FE8MSPOE+

10-Port Managed Switch with 30 W PoE+

2 Gigabit Combo Ports (SFP/RJ-45)

8 10/100 Mbps Copper Ports (TX) with PoE+

Operating temperature range of 0° to +50° C

The ComNet CWGE2FE8MSPOE+ commercial grade managed Ethernet switch provides eight ports of 10/100 BASE-TX PoE+ and two ports of 10/100/1000TX or 1000FX transmission. Auto-negotiating and auto-MDI/MDIX features are provided for simplicity and ease of installation. All eight ports support IEEE.802.3at based PoE+. Two ports are 10/100/1000 configurable for copper or fiber media for use with multimode or single mode optical fiber, selected by optional SFP* modules.

Additional Features

› Eight electrical ports support IEEE.802.3at (30 W) PoE+ with a total PoE budget of 240 W

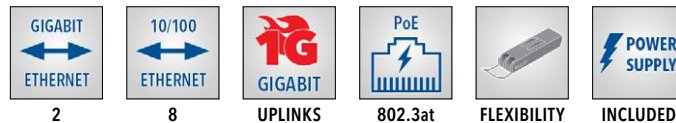

CWGE10FX2TX8MS

10-Port All-Gigabit Managed Switch

2 Gigabit SFP Ports (FX)

8 Gigabit Copper Ports (TX)

Operating temperature range of 0° to +50° C

The ComNet CWGE10FX2TX8MS switch that has two 100/1000FX SFP* ports and eight 10/100/1000Base-TX ports. The IEEE802.3-compliant unit offers multiple Ethernet redundancy protocols that protect your network from failure. The switch provides advanced IP-based management that can limit the maximum bandwidth for each connected IP device, allowing the user to adjust usage.

Additional Features

› Fast Redundancy/Recovery – RSTP/STP (IEEE802.1w/D)



CWGE10FX2TX8MSPOE

10-Port All-Gigabit Managed Switch with 30 W PoE+

2 Gigabit SFP Ports (FX)

8 Gigabit Copper Ports (TX) with PoE+

Operating temperature range of 0° to +50° C

The ComNet CWGE10FX2TX8MSPOE is a 10-port commercial managed Ethernet switch that has two 100/1000FX SFP* ports and eight 10/100/1000Base-TX ports. The IEEE802.3-compliant unit offers multiple Ethernet redundancy protocols that protect your network from failure. The switch provides advanced IP-based management that can limit the maximum bandwidth for each connected IP device, allowing the user to adjust usage. CWGE10FX2TX8MSPOE features 8 Ports that provide up to 30 Watts of PoE+.

Additional Features

› Eight electrical ports support IEEE.802.3at (30 W) PoE+ with a total PoE budget of 120 W

› Fast Redundancy/Recovery – RSTP/STP (IEEE802.1w/D)

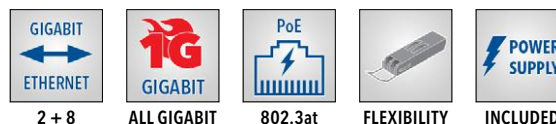



CWGE24MS2

24-Port All-Gigabit Managed Layer 2+ Switch

4 Gigabit Combo Ports (SFP/RJ-45)

20 Gigabit SFP Ports (FX)

Operating temperature range of 0° to +50° C

The ComNet CWGE24MS2 is a 24-port commercial managed Ethernet switch that has four 10/100/1000Base-TX RJ45 or 100/1000Base-FX SFP* combo ports and twenty 100/1000Base-FX SFP ports. The IEEE802.3-compliant unit offers multiple Ethernet redundancy protocols that protect your network from failure. The switch provides advanced IP-based management that can limit the maximum bandwidth for each connected IP device, allowing the user to adjust usage.

Additional Features

- › Internal 100-240 VAC Power Supply & 12 VDC battery Backup Input
- › Fast Redundancy/Recovery – MSTP/RSTP/STP (IEEE802.1s/w/D) and ERPS G.8032

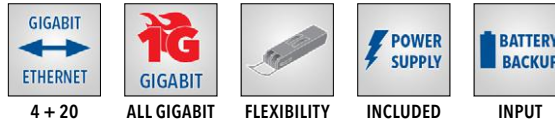

CWGE26FX2TX24MS

26-Port Extended Temperature, All-Gigabit Managed Switch

2 Gigabit SFP Ports (FX)

2 Gigabit Combo Ports (SFP/RJ-45)

22 Gigabit Copper Ports (TX)

Operating temperature range of -10° to +60° C

The ComNet CWGE26FX2TX24MS is a commercial Managed Ethernet Switch. It provides twenty-two 10/100/1000BASE-T(X) ports, plus two gigabit combo ports which are user-selectable between 10/100/1000BASE-T(X) ports or two 100/1000FX SFP* ports. A further two-100/1000FX SFP* ports are also included. All SFP ports utilize ComNet SFPs for fiber and connector type and distance. The CWGE26FX2TX24MS is a redundant switch offering multiple Ethernet redundancy protocols to protect your applications from network interruptions or temporary malfunctions by redirecting transmission within the network.



CWGE26FX2TX24MSPOE

26-Port Extended Temperature, All-Gigabit Managed Switch with 30 W PoE+

2 Gigabit SFP Ports (FX)

2 Gigabit Combo Ports (SFP/RJ45) with PoE

22 Gigabit Copper Ports (TX) with PoE

Operating temperature range of -10° to +60° C

The ComNet CWGE26FX2TX24MSPOE is an extended temperature, all-gigabit, commercial grade managed Ethernet switch. It provides IEEE 802.3at PoE to twenty-four 10/100/1000BASE-T(X) ports, two of which are also gigabit combo ports supporting 100/1000FX SFP Modules. A further two 100/1000FX SFP* ports are also included. Up to 320 watts of PoE power is available for distribution across all twenty-four TX ports. The switch offers multiple Ethernet redundancy protocols to protect your applications from network interruptions or temporary malfunctions by redirecting transmission within the network.

Additional Features

- › CWGE26FX2TX24MSPOE provides IEEE.802.3at (30 W) PoE+ budget of 320 W to 24 TX ports

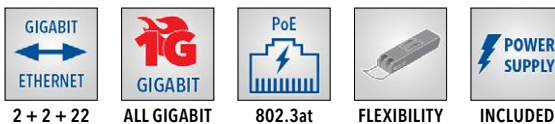

* Requires purchase of SFP modules (sold separately). See Page 37.



CTS

CTS24+2[POE][HO] Series
Commercial Managed Transport System
with 30 W PoE+

- 8 100 Mbps SFP Ports (FX)
- 8 10/100 Mbps Copper Ports (TX)
- 8 CopperLine® Extended Distance Coaxial Ports
- 8 CopperLine® Extended Distance UTP Ports

MADE IN THE USA

The ComNet CTS24+2 commercial grade managed Ethernet transport system provides up to 24 ports of 10/100 Ethernet and two ports of 10/100/1000TX or 100/1000FX transmission. The system includes a chassis with optional PoE supplies of 400 or 1000 Watts. Additionally, up to three 8 channel modules can be ordered to populate the system. These modules are offered in conventional CAT5/6 10/100 Mbps Ethernet, optical SFP supporting 100FX, or ComNet exclusive CopperLine® interfaces of either Coax or UTP.

Additional Features

- › Three module slots: Combine standard copper, optical, and extended distance Ethernet in one rack mounted chassis configuration
- › Optional 30 W with Internal Power Supply
- › Light Management Functionality Including IGMP and RSTP
- › Chassis and modules are ordered individually, and assembled at the factory to insure your configuration is tested as a complete unit.

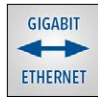

2



24



UPLINKS



802.3at



FLEXIBILITY



INCLUDED



EXTENDER

Unmanaged Ethernet Switches

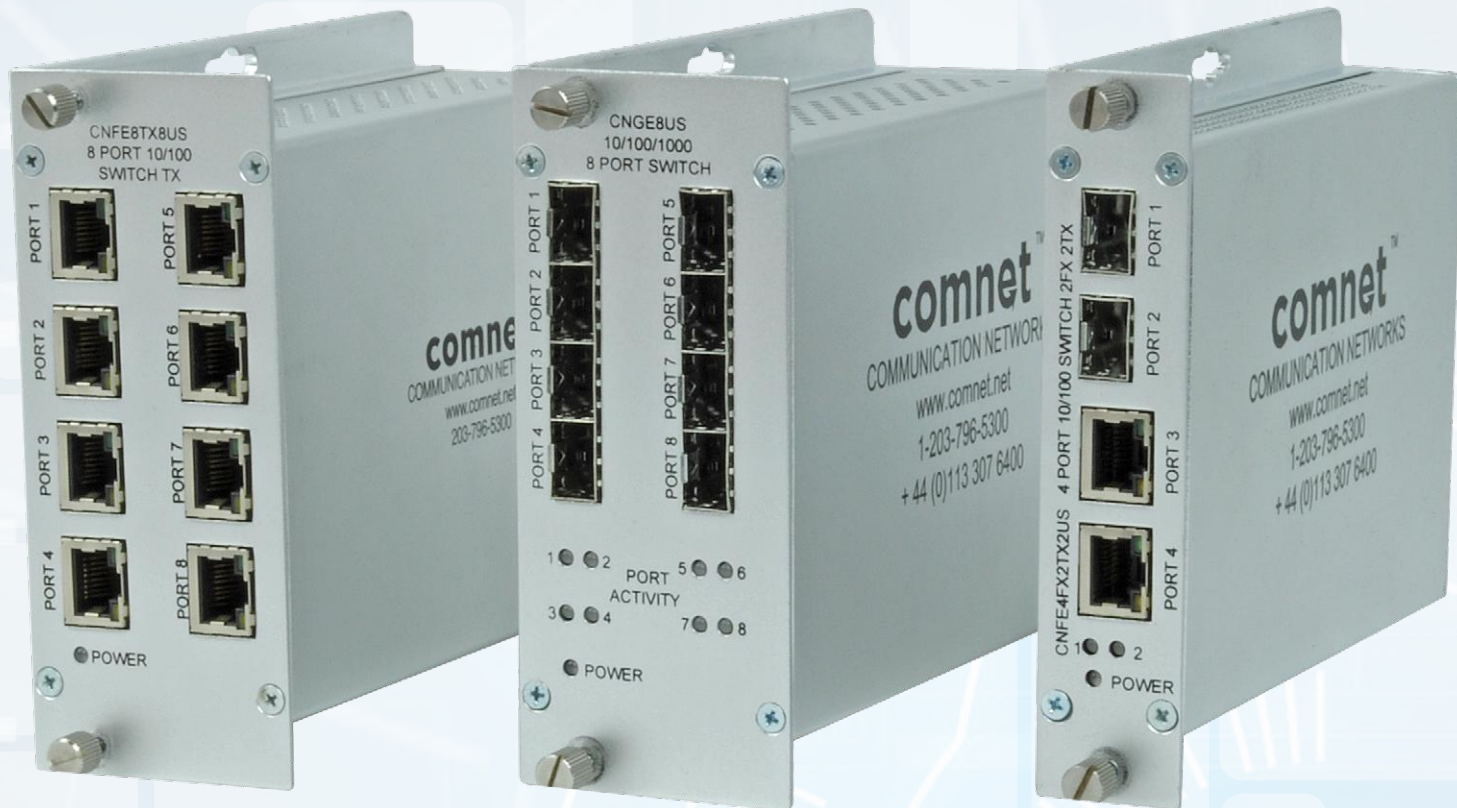

The ComNet unmanaged Ethernet switch series consists of 10/100TX and Gigabit Ethernet models in four and eight port channel counts. These hardened devices are made in the USA for the highest level of reliability and are available in all-electrical, electrical and optical and all optical configurations. The ComNet unmanaged switch series uses MSA-compliant ComNet SFP modules for maximum versatility with regard to distance, fiber type and optical connector type.

Unmanaged Ethernet Switches feature:

- › Environmentally hardened for deployment in difficult, unconditioned out-of-plant and roadside installations, they have an extended ambient operating temperature range of -40° to +75° C
- › 10/100/1000TX and 100/1000FX compatible
- › Flexible optical and copper-based configuration via SFP* plug-in modules
- › Auto-negotiating and auto-MDI/MDIX features for simplicity and ease of installation
- › HD Video Compatible
- › Made in the USA
- › Lifetime Warranty

* Requires purchase of SFP modules (sold separately). See Page 37.



CNFE4US Series
4-Port 100 Mbps Unmanaged Switches

MADE IN THE USA

The ComNet CNFE4US Ethernet four port unmanaged switches transport 100 Mbps data over optical fiber through user selectable SFP* options or 10/100 Mbps data over CAT-5e/6 electrical cable. The series consists of models in all electrical, electrical and SFP optical and all optical. The ComNet unmanaged switch series uses MSA-compliant ComNet SFP optical interfaces for maximum configuration versatility with regard to distance, fiber type and optical connector requirements.

Additional Features

- › CNFE4FX4US offers four 100 Mbps SFP Optical Ports
- › CNFE4FX2TX2US offers two 100 Mbps SFP Optical Ports and two 10/100 Mbps Copper Ports
- › CNFE4TX4US offers four 10/100 Mbps Copper Ports

10/100 ↔ ETHERNET	 FLEXIBILITY	HARDENED -40° TO +75°	 INCLUDED
4			



CNFE8US Series
8-Port 10/100 Mbps Unmanaged Switches

MADE IN THE USA

ComNet CNFE8US Ethernet 8 port unmanaged switch series transport 10/100 Mbps data over optical fiber through user selectable SFP* options or 10/100 Mbps data over CAT-5e/6 electrical cable. The series consists of models in all electrical, electrical and SFP optical and all optical. The ComNet unmanaged switch series uses MSA-compliant ComNet SFP optical interfaces for maximum configuration versatility with regard to distance, fiber type and optical connector requirements.

Additional Features

- › CNFE8FX8US offers eight 100 Mbps SFP Optical Ports
- › CNFE8FX4TX4US offers four 100 Mbps SFP Optical Ports and four 10/100 Mbps Copper Ports
- › CNFE8TX8US offers eight 10/100 Mbps Copper Ports

10/100 ↔ ETHERNET	 FLEXIBILITY	HARDENED -40° TO +75°	 INCLUDED
8			



CNGE4TX4US/M
4-Port All-Gigabit Unmanaged Switch

MADE IN THE USA

The ComNet CNGE4TX4US Ethernet 4 port unmanaged switch transports 10/100/1000 Mbps data over CAT-5e/6 electrical cable. Available in a mini sized housing ensures the switch can be installed in the most space constrained installations.

GIGABIT ↔ ETHERNET	 ALL GIGABIT	HARDENED -40° TO +75°	 INCLUDED
4			



CNGE4US Series
4-Port All-Gigabit Unmanaged Switches

MADE IN THE USA

The ComNet CNGE4US Ethernet four port unmanaged switches transport 10/100/1000 Mbps data over optical fiber or 10/100/1000 Mbps data over CAT-5e/6 electrical cable through user selectable SFP* options. The ComNet unmanaged switch series uses MSA-compliant ComNet SFP optical interfaces for maximum configuration versatility with regard to distance, fiber type and optical connector requirements.

Additional Features

› All ports support 1000 Mbps full duplex data

4	FLEXIBILITY	-40° TO +75°	INCLUDED



CNGE4TX4USPOE[HO]/M
4-Port All-Gigabit Unmanaged Switch with 30 W PoE+ / 60 W Universal PoE

MADE IN THE USA

The ComNet CNGE4TX4USPOE[HO] Ethernet 4 port unmanaged switch transports 10/100/1000 Mbps data over CAT-5e/6 electrical cable. Two PoE models are available; the CNGE4TX4USPOE/M features four ports that provide up to 30 watts of PoE+. The CNGE4TX4USPOEHO/M features four ports that can provide up to 60 watts of Universal PoE power.

4	ALL GIGABIT	802.3at	-40° TO +75°



CNGE8US
8-Port All-Gigabit Unmanaged Switch

MADE IN THE USA

The ComNet CNGE8US Ethernet 8 port unmanaged switch transports 1000 Mbps data over optical fiber or 10/100/1000 Mbps data over CAT-5e/6 electrical cable through user selectable SFP*s. The ComNet unmanaged switch series uses MSA-compliant ComNet SFP modules for maximum configuration versatility with regard to media, distance, fiber type and optical connector requirements.

Additional Features

› All ports support 1000 Mbps full duplex data

8	ALL GIGABIT	FLEXIBILITY	-40° TO +75°	INCLUDED

* Requires purchase of SFP modules (sold separately). See Page 37.

Self-Managed Ethernet Switches

No Programming Required



The ComNet Self-Managed Switch Series are a line of switches that allow incoming Ethernet data to be electrically or optically forwarded to another Ethernet device.

The ComNet self-managed switch series with uplink management functionality is designed to combine data from the electrical ports to the last electrical or optical port and forwards this data to the next network device. There is no programming required to use this product. The ComNet SMS line is pre-programmed, preventing network video flooding with dip switch selection of the last port as an uplink or as an unmanaged switch. PoE models of the SMS series supply up to sixty watts of PoE (Power over Ethernet) and incorporate PoE+ features based on the IEEE802.3at standard.

Self-Managed Ethernet Switches feature:

- › No Programming Required
- › 10/100 Mbps or 1Gbps Ethernet available
- › Two, four or six electrical ports supporting 30 W PoE+ or 60 W Universal PoE
- › Extended operating temperature range of -40° C to +75° C, for use in virtually any environment.
- › One or two optical ports
- › Multimode or Single-mode Fiber, SC or ST connector types, or SFP* connections available across the range
- › Electrical ports support Auto-Negotiation for speed as well as full duplex or half duplex data
- › Optical port models support 100 Mbps or 1000 Mbps full duplex data
- › Pre-programmed Port for uplink

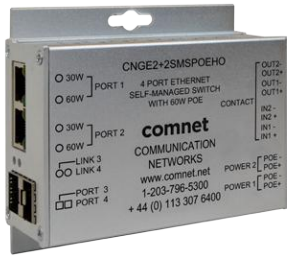

CNGE2+2SMS and CNGE2+2SMSPOE[HO]
 4-Port All-Gigabit Self-Managed Switches with 30 W PoE+ / 60 W Universal PoE

MADE IN THE USA

The ComNet CNGE2+2SMS[POE][HO] are a series of four-port Gigabit hardened self-managed Ethernet Switches with light management functionality. They feature two 10/100/1000BASE-TX and two 100/1000FX SFP ports. The Self-Management function (SMS) allows the user to enable RSTP and IGMP by selecting settings on switches located on the unit. Two PoE models are available; the CNGE2+2SMSPOE features two ports that provide up to 30 Watts of PoE+. The CNGE2+2SMSPOEHO features two ports that can provide up to 60 watts of Universal PoE power.

Additional Features

- › CNGE2+2SMSPOE provides 30 W PoE+ to the two 10/100/1000BASE-T(X) electrical ports
- › CNGE2+2SMSPOEHO provides 60 W PoE++ to the two 10/100/1000BASE-T(X) electrical ports

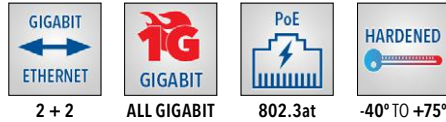

CNGE4SMS/M and CNGE4SMSPOE[HO]/M
 4-Port All-Gigabit Self-Managed Switches with 30 W PoE+ / 60 W Universal PoE

MADE IN THE USA

The ComNet CNGE4SMS[POE][HO]/M are a series of four-port Gigabit hardened self-managed Ethernet Switches with light management functionality. They feature four 10/100/1000BASE-TX ports. The Self-Management Function allows the user to enable RSTP and IGMP by selecting settings on switches located on the unit. Two PoE models are available; the CNGE4SMSPOE/M features four ports that provide up to 30 watts of PoE+. The CNGE4SMSPOEHO/M features four ports that can provide up to 60 watts of Universal PoE power.

Additional Features

- › 10/100/1000 Mbps Ethernet
- › CNGE4SMSPOE/M provides 30 W PoE+ to the four 10/100/1000BASE-T(X) electrical ports
- › CNGE4SMSPOEHO/M provides 60 W Universal PoE to the four electrical ports.

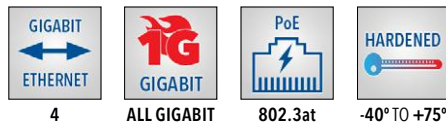

CNFE4SMS and CNFE4SMSPOE
 4-Port 10/100 Mbps TX Self-Managed Switches

MADE IN THE USA

The ComNet CNFE4SMS and CNFE4SMSPOE are four port switches with uplink management functionality providing four Ethernet ports operating at 10/100 Mbps and are designed to combine three electrical ports into an electrical port that forwards this data to the next network device. All four ports of the CNFE4SMSPOE can supply up to 30 watts of PoE and incorporate PoE+ features based on the IEEE 802.3at standard.

Additional Features

- › 10/100 Mbps Ethernet
- › CNFE4SMSPOE provides PoE+ to the 4 10/100BASE-T(X) electrical ports
- › Automatic MDI/MDI-X crossover

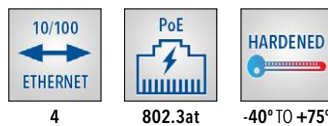

* Requires purchase of SFP modules (sold separately). See Page 37.



CNFE4+1SMS(M,S)2 and CNFE4+1SMS(M,S)2POE
5-Port 10/100 4TX+1FX Self-Managed Switches

MADE IN THE USA

The ComNet CNFE4+1SMS(M,S)2 is a five-port self-managed Ethernet switch with uplink management functionality. It provides four ports operating at 10/100 Mbps and is designed to combine Ethernet data from the four electrical ports into a single optical port and forward that data to the next network device, using two-fiber ST or SC optical connectors.

Additional Features

› CNFE4+1SMS(M,S)2POE provides 30 W PoE+ to the 4 10/100BASE-T(X) electrical ports

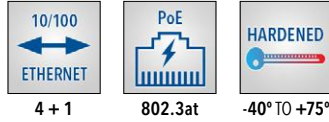

CNFE5SMS and CNFE5SMSPOE
10/100TX 5TX Self-Managed Switches

MADE IN THE USA

The ComNet CNFE5SMS and CNFE5SMSPOE are five port switches with uplink management functionality providing five Ethernet ports operating at 10/100Mbps and are designed to combine four electrical ports into an electrical port that forwards this data to the next network device. The four electrical ports of the CNFE5SMSPOE can supply up to 30 watts of PoE and incorporate PoE+ features based on the IEEE 802.3at standard.

Additional Features

› CNFE5SMSPOE provides PoE+ to the 4 10/100BASE-T(X) electrical ports

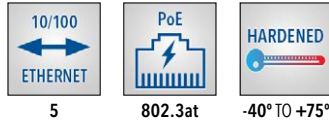

CNGE4+2SMS[M] and CNGE4+2SMSPOE[HO]/M
6-Port All-Gigabit Self-Managed Switches with 30 W PoE+ / 60 W Universal PoE

MADE IN THE USA

The ComNet CNGE4+2SMS[POE][HO]/M are a series of six-port Gigabit hardened self-managed Ethernet Switches with light management functionality. They feature four 10/100/1000BASE-TX and two 100/1000FX SFP* ports. The Self-Management function (SMS) allows the user to enable RSTP and IGMP by selecting settings on switches located on the unit. Two PoE models are available.

Additional Features

› CNGE4+2SMSPOE/M provides 30 W PoE+ to the four 10/100/1000BASE-T(X) electrical ports

› CNGE4+2SMSPOEHO/M provides 60 W Universal PoE to the four 10/100/1000BASE-T(X) electrical ports

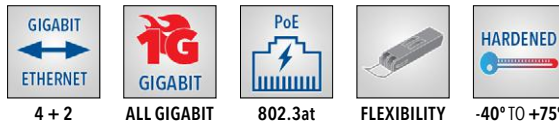

CNGE2FE4SMS and CNGE2FE4SMSPOE[HO]
Gigabit Self-Managed Switches with 30 W PoE+ / 60 W Universal PoE

MADE IN THE USA

The ComNet CNGE2FE4SMSPOE[HO] is a six-port self-managed switch with uplink management functionality and provides four copper ports operating at 10/100 Mbps and two 1000FX optical SFP* ports. It is designed to combine four electrical ports and one 1000FX SFP port into one of two optical SFP ports. The CNGE2FE4SMSPOE[HO] SFP ports forward this data to the next network device or can be configured for drop and insert operation. The CNGE2FE4SMSPOE[HO] uses ComNet SFPs for connector and distance options. Two PoE models are available.

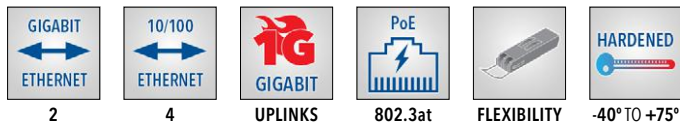







CNGE5+1SMSPOEPD/M
6-Port All-Gigabit Self-Managed Switch
with 30 W PoE+ (60 W PD)

MADE IN THE USA

The ComNet CNGE5+1SMSPOEPD/M is a six-port Gigabit hardened self-managed Ethernet Switch with light management functionality. It features five 10/100/1000BASE-TX ports and one 100/1000FX SFP* port. The Self-Management function (SMS) allows the user to enable RSTP and IGMP by selecting settings on switches located on the unit. The device can operate as a PD (powered device) by accepting up to 60W of PoE from a PoE switch to provide operating power as well as distribute PoE to other connected devices. The CNGE5+1SMSPOEPD/M features four ports that can provide up to 30 watts of PoE+ power.

 GIGABIT ETHERNET 5 + 1	 ALL GIGABIT	 PoE 802.3at	 FLEXIBILITY	 HARDENED -40° TO +75°
---	--	---	---	---









CLGE5+1SMSPOEPD/M
6-Port Gigabit Self-Managed Switch
with 30 W PoE+

MADE IN THE USA

The ComNet CLGE5+1SMSPOEPD/M is a six-port Gigabit hardened self-managed Ethernet Switch with light management functionality. The device features four electrical, one SFP* and one distance-extending CopperLine® ports. The Self-Management function allows the user to enable RSTP and IGMP by selecting settings on switches located on the unit. The device accepts up to 30W of PoE from a PoE switch via the CopperLine® port to provide operating power as well as distribute PoE to other connected devices.

Additional Features

- › Provides PoE to the 4 10/100/1000BASE-T(X) electrical ports
- › One CopperLine uplink port supports user selectable UTP or Coax interfaces



 GIGABIT ETHERNET 5	 10/100 ETHERNET 1	 PoE 802.3at	 FLEXIBILITY	 HARDENED -40° TO +75°	 ETHERNET OVER COPPER EXTENDER
--	---	--	--	--	--



CNFE6+2USPOE
10/100TX Drop/Insert/Repeat
6TX/2FX Self-Managed Switches
with 30 W PoE+

MADE IN THE USA

The ComNet CNFE6+2USPOE provides eight Ethernet ports operating at 10/100 Mbps and is designed to combine six electrical ports into a second optical port that forwards this data to the next CNFE6+2USPOE. The optical ports are designed to forward the data from the six electrical ports to the next switch, to a PC, or another Ethernet connection. In addition, the electrical ports can supply up to 30 watts of PoE to remote Ethernet devices. This product uses ST optical connections and can be supplied to operate over Singlemode or Multimode optical fiber.

 10/100 ETHERNET 6 + 2	 PoE 802.3at	 HARDENED -40° TO +75°
--	---	---

* Requires purchase of SFP modules (sold separately). See Page 37.

Ethernet Electrical-to-Optical Media Converters

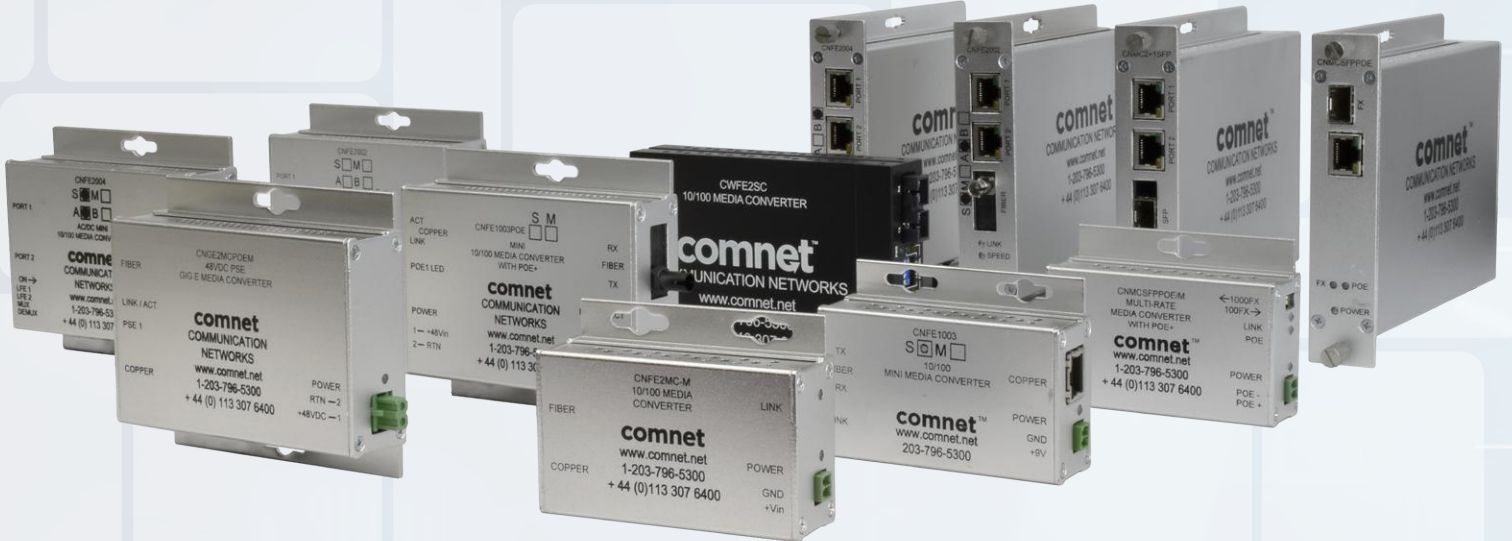

ComNet offers many different variations of simple media converters with numerous optical connector options.

The ComNet media converter line consists of one and two fiber fixed SC and ST optical connector models as well as 10/100TX and Gigabit models that utilize MSA-compliant ComNet SFP optical interfaces for maximum configuration versatility with regard to distance, fiber type and optical connector requirements.

ComNet Media Converters feature:

- › 10/100 Mbps Ethernet with MDI/MDI-X crossover
- › 10/100/1000TX electrical port and 100/1000FX optical port
- › Electrical port supports Auto-Negotiation for 10 Mbps or 100 Mbps, full or half duplex data
- › Optical port supports 100 Mbps or 1000 Mbps full duplex data
- › Distances up to: 3km (2mi) in Multimode or 20km (12mi) in Single Mode (greater distances achievable with SFP* models)
- › Extended ambient operating temperature range: -40° to +75° C
- › ST, SC or LC optical connectors
- › Flexible optical and copper-based configuration via SFP plug-in modules
- › 1 or 2 fiber design
- › AC or DC powered models available
- › Standard size is interchangeable between stand-alone or rack mount use - smaller size available
- › IEEE 802.3 compliant
- › HD Video Compatible
- › Lifetime Warranty



CNFE100(X) Series
10/100 Mbps TX-to-FX Media Converters

MADE IN THE USA

ComNet two port media converters are designed to transmit and receive 10/100 Mbps data over multimode or single mode optical fiber. The electrical interface will Auto-Negotiate to a 10 Mbps or 100 Mbps Ethernet rate without any adjustments. Also available as an ultra-miniature 5cm × 5cm PCB for space restricted installations and direct-to-fiber In-Dome mounting for Bosch, Pelco and Vicon cameras.

Additional Features

› Environmentally hardened

<p>10/100 ETHERNET</p>	<p>HARDENED</p>	<p>POWER SUPPLY INCLUDED</p>	<p>TX ↔ FX ELECTRICAL TO OPTICAL CONVERTER</p>
1	-40° TO +75°		



CNFE200(X) Series
2 Channel 10/100 Mbps TX-to-FX Media Converters

MADE IN THE USA

The ComNet Ethernet CNFE200X series of media converters are two-channel Ethernet electrical to optical media converters. These auto-negotiating devices accept two 10/100 Mbps electrical inputs and convert this to a single 100 Mbps optical output. These media converters are available as multimode or single-mode and one and two fiber SC and ST optical connectors. The ComNet exclusive Demux feature allows for port isolation, replicating two media converters over one fiber. The ComNet exclusive Mux feature prevents network video flooding of multicast traffic with DIP switch selection of the fiber port as a dedicated uplink path.

<p>10/100 ETHERNET</p>	<p>HARDENED</p>	<p>POWER SUPPLY INCLUDED</p>	<p>TX ↔ FX ELECTRICAL TO OPTICAL CONVERTER</p>
2	-40° TO +75°		



CNFE2MC(-M) and CNFE22MC
10/100 Mbps Media Converters
SFP modules as Optical Interfaces

MADE IN THE USA

ComNet CNFE2MC and CNFE2MCM Ethernet two-port media converter and CNFE22MC dual two-port transport 10/100 Mbps data over optical fiber through user selectable MSA-compliant ComNet SFP* optical interfaces for maximum configuration versatility with regard to distance, fiber type and optical connector requirements. The CNFE2MC transmits and receives a single channel of Ethernet data and the CNFE22MC transmits and receives two independent channels in one unit.

Additional Features

› Environmentally hardened

› Distances up to 80km

<p>10/100 ETHERNET</p>	<p>FLEXIBILITY</p>	<p>HARDENED</p>	<p>POWER SUPPLY INCLUDED</p>	<p>TX ↔ FX ELECTRICAL TO OPTICAL CONVERTER</p>
1 OR 2		-40° TO +75°		

* Requires purchase of SFP modules (sold separately). See Page 37.



CNGE2MC(-M) and CNGE22MC
 10/100/1000 Mbps
 2 Port Media Converters

MADE IN THE USA

ComNet CNGE2MC and CNGE22MC two-port and dual two-port media converters provide full-duplex fiber optic transmission of 10/100/1000 Mbps Ethernet data (10/100/1000TX) through optical fiber when used with the appropriate ComNet MSA-compliant SFP*. The two-port CNGE2MC provides full-duplex transmission of one Ethernet channel through one or two fibers, depending upon the SFP selected. The dual two-port model CNGE22MC supports full-duplex transmission of two separate Ethernet channels over one or two optical fibers, also depending upon the SFP selected, in one compact package, making this unit ideal for those applications where rack density or shelf-space may be limited.

Additional Features

- › Environmentally hardened
- › Distances up to 120 km

1 OR 2	FLEXIBILITY	-40° TO +75°	INCLUDED	CONVERTER



CNMC[2]SFP/M
 User-Selectable 100FX or 1000FX
 Single Media Converter

MADE IN THE USA

The ComNet CNMC[2]SFP[M] series are multi-rate media converters that accept a 10/100 or 1000 Mbps electrical input and convert this to a 100 or 1000 Mbps optical output, selected by a dip switch. These devices use either one or two optical fibers, depending upon the selection of sold-separately SFP* optical module.

Additional Features

- › User Selectable 100FX or 1000FX Transmission Rate
- › Uses ComNet SFPs for Fiber and Connector Type and Distance
- › Environmentally Hardened

1 OR 2	1 OR 2	FLEXIBILITY	-40° TO +75°	INCLUDED	CONVERTER

Ethernet Electrical-to-Optical Media Converters with Power over Ethernet (PoE)



Many applications require power from the Power Sourcing Equipment (PSE) device to be supplied through the Ethernet cable including those where an Electrical-to-Optical media converter is being used to extend distances. Typical applications can include IP CCTV cameras, access control equipment, VoIP telephony and more.

ComNet Media Converters with Power over Ethernet (PoE) feature:

- › Meets the requirements of the latest PoE standard (IEEE 802.3at)
- › Power Sourcing Equipment (PSE): Provides 30 watts or up to 60 watts (PoE+) in A and B modes for high power demand applications of remote powered devices
- › SC or ST fixed optical connectors
- › SFP* models available
- › Environmentally Hardened

Applications:

- › PoE+ Operating Power for IP Cameras, with pan-tilt-zoom capability
- › PoE+ Operating Power for IP cameras with heated/cooled housings
- › PoE+ Operating Power for remote telemetry and sensing devices for industrial/SCADA networks
- › PoE+ Operating Power for transportation-specific/ITS field equipment

* Requires purchase of SFP modules (sold separately). See Page 37.

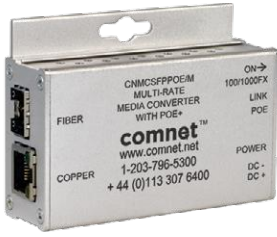

CNMCSFPPOE/M







Gigabit TX to FX Media Converter with PoE+

MADE IN THE USA

The ComNet CNMCSFPPOE/M is a multi-rate media converter that accepts a 10/100 or 1000 Mbps electrical input and converts this to a 100 or 1000 Mbps optical output, selected by a dip switch. The CNMCSFPPOE/M meets the IEEE802.3at standard and provides 30 watts of PoE+ power.

Additional Features

- › User Selectable 100FX or 1000FX Transmission Rate
- › Uses ComNet SFP*s for Fiber and Connector Type and Distance
- › Environmentally Hardened

 1	 1	 802.3at	 FLEXIBILITY	 -40° TO +75°	 CONVERTER
--	--	--	---	---	--



CNFE2MCPOE[M]

10/100 Mbps TX to FX Media Converter
Power over Ethernet (PoE)
Powered by 12 or 24 VDC

MADE IN THE USA

ComNet CNFE2MCPOE[M] Ethernet two-port media converters are designed to transmit and receive 10/100 Mbps data over optical fiber through user selectable SFP* options. These media converters transmit and receive a single channel of Ethernet data, and also support the IEEE 802.3at standard for power sourcing equipment (PSE) at up to 30 watts of PoE+ power.

Additional Features

- › Uses ComNet SFPs for Fiber and Connector Type and Distance
- › Environmentally Hardened

 1	 802.3at	 FLEXIBILITY	 -40° TO +75°	 CONVERTER
--	--	--	--	--



CNGE2MCPOEM





Gigabit TX to FX Media Converter
Power over Ethernet (PoE)

MADE IN THE USA

ComNet CNGE2MCPOEM Ethernet two-port media converters are designed to transmit and receive 10/100/1000 Mbps data over optical fiber through user selectable SFP* options. These models transmit and receive a single channel of Ethernet data, and support the IEEE 802.3at standard for power sourcing equipment (PSE) up to 30 watts of PoE+ power.

Additional Features

- › 1000FX Transmission Rate
- › Uses ComNet SFPs for Fiber and Connector Type and Distance
- › Environmentally Hardened

 1	 802.3at	 FLEXIBILITY	 -40° TO +75°	 CONVERTER
--	--	--	--	--



CNFE100(X)POE/M Series
10/100 Mbps TX to FX Media Converters
 Electrical to ST/SC/SFP Optical with PoE+

MADE IN THE USA

The CNFE100(X)POE/M Series hardened media converters provide full-duplex fiber optic transmission of a single channel of 10/100 Mbps data over multimode or single mode optical fiber. Type ST, SC or SFP* optical connectors are available. They provide full compliance with IEEE 802.3at as Power Sourcing Equipment (PSE) with a maximum power of 30 watts, making them ideal for those applications where the remote equipment draws significant power. A higher output 60 watt model is available.

Additional Features

- › Provides 30 watts in two modes at 48 VDC, for high output demand applications
- › 60 watt higher output version available

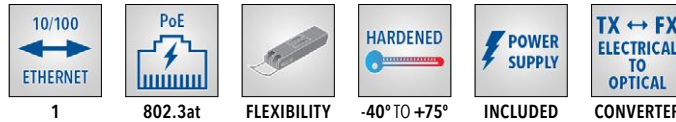

CNFE200(X)POE[HO] Series
2 Channel 10/100 Mbps TX to FX
Media Converter with
Optional 30 W PoE+ / 60 W Universal PoE

MADE IN THE USA

The ComNet Ethernet CNFE200X series of media converters are two-channel Ethernet electrical to optical media converters with optional PoE+. These auto-negotiating devices accept two 10/100 Mbps electrical inputs and convert this to a single 100 Mbps optical output. These media converters are available as multimode or single-mode and one and two fiber SC and ST optical connectors. The ComNet exclusive Demux feature allows for port isolation, replicating two media converters over one fiber. The ComNet exclusive Mux feature prevents network video flooding of multicast traffic with DIP switch selection of the fiber port as a dedicated uplink path.

Additional Features

- › Environmentally hardened
- › The CNFE200(X)POE units provide 30 W 802.3at PoE+
- › The CNFE200(X)POEHO units provide 60 W 802.3at Universal PoE



Power over Ethernet (PoE)
Mid-Span Injection Modules
Five Year Warranty

Features

- › Supply 48 or 56 VDC operating power for PSE devices
- › PoE and Ethernet Data
- › Fully Compliant with IEEE Standards for Power Sourcing Equipment
- › Provides Short Circuit Protection for PDs

Available Models

CWPOEIPS-15	15 W Commercial PoE midspan injector, IEEE 802.3af compliant PSE
CNGE1IPS	30 W Industrial Gigabit PoE+ midspan injector, IEEE 802.3at compliant PSE

* Requires purchase of SFP modules (sold separately). See Page 37.

Ethernet Integration

Integrating legacy serial data and Contact Closure devices over an Ethernet network has never been easier.



CNFE2DOE2
RS232/422/485 Data over Ethernet Terminal Server

MADE IN THE USA

The ComNet CNFE2DOE2 allows any combination of two RS-232, RS-422, or 2 or 4-wire RS-485 serial data channels be transported by any Ethernet-based network. It includes two serial data input/output ports, and two Ethernet ports. Serial data appearing on either of the two serial data ports is converted to Ethernet, and transmitted to both the SFP* and RJ-45 ports, permitting the unit to be used as a media converter and a terminal server.

Additional Features

- › Easy configuration through web interface (HTTP)

10/100 ETHERNET	2 DATA	FLEXIBILITY	-40° TO +75°	INCLUDED



CNFE8(X)COE
Eight Channel Contact Closure over Ethernet

MADE IN THE USA

The ComNet CNFE8(X)COE transmits eight contact closures over an Ethernet network. It is available with a 10/100TX RJ45 Ethernet connector and an SFP* fiber optic interface. These units can be one-to-one mapped over Ethernet or controlled via a PC. Included is a driver that allows the CNFE8(X)COE to read or write contact information from a PC based application. A software utility allows customers to search for this device that is installed on the network. The transmitter and receiver support Windows® Discovery.

Additional Features

- › NTCIP compatible
- › Remote network configuration

10/100 ETHERNET	8 CONTACT CLOSURE	FLEXIBILITY	-40° TO +75°	INCLUDED



CNFE1RPT[/PD][/M]
10/100 Mbps Ethernet Repeater with 60 W Pass-Through PoE++

MADE IN THE USA

The ComNet CNFE1RPT can be used to double the distance to 656 feet (200 meters) or multiple units can be combined in series with each unit providing an additional 328 feet (100 meters) of full unrestricted 10/100 Mbps bandwidth. The CNFE1RPT is powered by pass-through PoE from a PoE switch or midspan injector, requiring no local power. Low power consumption ensures that maximum power is made available to the remote PD device.

Additional Features

- › Available as PoE pass-through configuration, or as the final PoE unit with no pass through PoE

10/100 ETHERNET	PoE 802.3at	PoE PASS-THRU	-40° TO +75°



ComNet Flexibility

Small Form-Factor Pluggable Modules (SFPs)

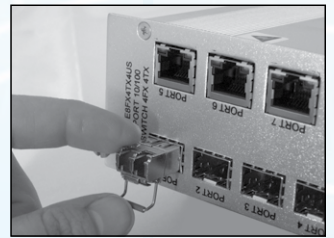
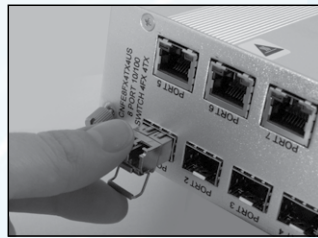
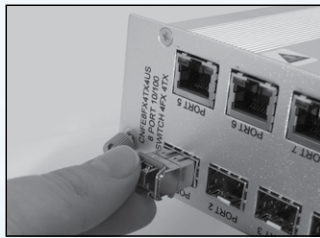

ComNet's **Small Form-Factor Pluggable modules** provide an optical or copper interface when using any ComNet managed or unmanaged switch or SFP-configurable media converters. These SFP modules are available for use with copper media, or Multimode or Single-mode optical fiber. The optical fiber SFP modules provide 10/100 or 10/100/1000FX transmission in one or two fiber versions. They are available with LC or SC optical connectors. These ComNet SFPs offer distances from 300 meters to 120 kilometers. Industrially rated to perform in the **most difficult operating environments**, ComNet SFPs are **MultiSource Agreement (MSA) compliant**.

COPPERLINE[®]

Distance Extending Ethernet over Copper SFP

The ComNet CopperLine[®] CL-SFP is a small form-factor pluggable Ethernet extender module that improves bandwidth and distance of existing copper networks. It helps avoid installation costs of new fiber lines on site by allowing full 100 Mbps Ethernet bandwidth to be extended over 2-wire twisted pair or coaxial cable. It is designed for plug-and-play installation into any Ethernet unit with an MSA-compliant, 100 Mbps SFP port.

Additional Features

- › Point-to-point Ethernet connectivity up to 2,000 ft (609 m) at 100 Mbps
- › Extends Ethernet distance over single pair UTP or coax with adapter
- › Can be plugged into any Ethernet switch with MSA-compliant SFP ports that support 100BASE-FX

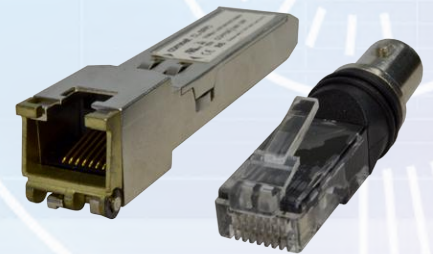

CL-SFP and CLRJ2COAX
Distance Extending SFP Series



For more information see the ComNet CopperLine[®] Brochure, available as a PDF or in print or online at <http://www.comnet.net/resources/product-literature/>

TRANSMISSION SOLUTIONS FOR THE LONG RUN

Fiber Optic Video, Audio and Data Transmission Products

ComNet offers a comprehensive selection of single and multiple channel video and video and data transmission products as well as serial data and audio transmission products designed to the specific requirements for Access Control, Intrusion, Burglar and Fire Alarms and CCTV Surveillance/Incident Detection and the Intelligent Transportation Systems (ITS) market. ComNet manufactures a complete line of in-dome video and data and Ethernet fiber optic modules for many of today's leading CCTV manufacturers.

Technical Support

The ComNet Technical Support and Design Center provides pre-sale and post-sale support for Ethernet transmission network and fiber optic system design. The department is staffed by some of the most highly experienced, regarded and recognized experts in the industry.

Our direct Design Center phone number is **1-888-678-9427** or you can call **1-203-796-5300** in the US or **+44 (0)113 307 6409** throughout Europe and ask for the Design Center, or contact us by E-mail at **designcenter@comnet.net**

comnet

Communication Networks

www.comnet.net

3 Corporate Drive | Danbury, CT 06810 | USA
T: 1-203-796-5300 | F: 1-203-796-5303
Tech Support: 1-888-678-9427
info@comnet.net

8 Turnberry Park Road
Gildersome | Morley | Leeds, UK LS27 7LE
T: +44 (0)113 307 6400
info-europe@comnet.net

AGENCY COMPLIANCE

